



# Full wwPDB X-ray Structure Validation Report ⓘ

Mar 20, 2026 – 08:47 AM UTC

PDB ID : 9XV9 / pdb\_00009xv9  
Title : Crystal structure of single-strand DNA-stabilized Ag16 nanocluster: T5 linker  
Authors : Ruck, V.; Kanazawa, H.; Huang, Z.; Kondo, J.; Vosch, T.  
Deposited on : 2025-11-26  
Resolution : 2.00 Å(reported)

This is a Full wwPDB X-ray Structure Validation Report for a publicly released PDB entry.

We welcome your comments at [validation@mail.wwpdb.org](mailto:validation@mail.wwpdb.org)

A user guide is available at

<https://www.wwpdb.org/validation/2017/XrayValidationReportHelp>

with specific help available everywhere you see the ⓘ symbol.

The types of validation reports are described at

<http://www.wwpdb.org/validation/2017/FAQs#types>.

---

The following versions of software and data (see [references ⓘ](#)) were used in the production of this report:

MolProbity : 4-5-2 with Phenix2.0  
Xtrriage (Phenix) : 2.0  
EDS : 3.0  
Percentile statistics : 20250101.v01 (using entries in the PDB archive January 1st 2025)  
CCP4 : 9.0.010 (Gargrove)  
Density-Fitness : 1.0.12  
Ideal geometry (proteins) : Engh & Huber (2001)  
Ideal geometry (DNA, RNA) : Parkinson et al. (1996)  
Validation Pipeline (wwPDB-VP) : 2.49

# 1 Overall quality at a glance

The following experimental techniques were used to determine the structure:

*X-RAY DIFFRACTION*

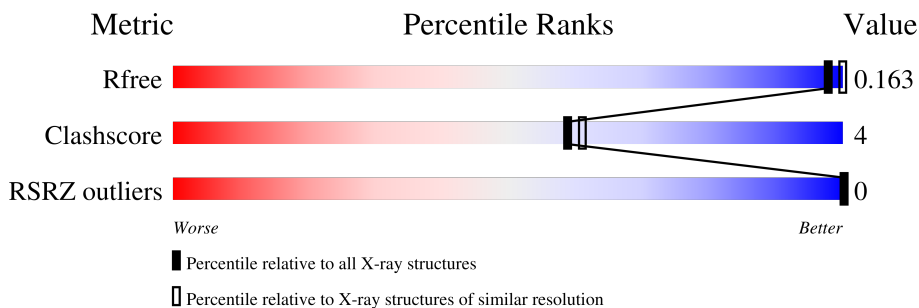

The reported resolution of this entry is 2.00 Å.

Percentile scores (ranging between 0-100) for global validation metrics of the entry are shown in the following graphic. The table shows the number of entries on which the scores are based.



Metric	Whole archive (#Entries)	Similar resolution (#Entries, resolution range(Å))
$R_{free}$	180053	10052 (2.00-2.00)
Clashscore	190562	11152 (2.00-2.00)
RSRZ outliers	180081	10067 (2.00-2.00)

The table below summarises the geometric issues observed across the polymeric chains and their fit to the electron density. The red, orange, yellow and green segments of the lower bar indicate the fraction of residues that contain outliers for  $\geq 3$ , 2, 1 and 0 types of geometric quality criteria respectively. A grey segment represents the fraction of residues that are not modelled. The numeric value for each fraction is indicated below the corresponding segment, with a dot representing fractions  $\leq 5\%$ . The upper red bar (where present) indicates the fraction of residues that have poor fit to the electron density. The numeric value is given above the bar.

Mol	Chain	Length	Quality of chain
1	A	25	
1	C	25	

## 2 Entry composition [i](#)

There are 4 unique types of molecules in this entry. The entry contains 917 atoms, of which 0 are hydrogens and 0 are deuteriums.

In the tables below, the ZeroOcc column contains the number of atoms modelled with zero occupancy, the AltConf column contains the number of residues with at least one atom in alternate conformation and the Trace column contains the number of residues modelled with at most 2 atoms.

- Molecule 1 is a DNA chain called DNA (5'-D(\*CP\*AP\*CP\*CP\*TP\*AP\*GP\*CP\*GP\*AP\*TP\*CP\*AP\*CP\*CP\*TP\*AP\*GP\*CP\*GP\*A)-3').

Mol	Chain	Residues	Atoms					ZeroOcc	AltConf	Trace
1	A	21	Total	C	N	O	P	0	0	0
			423	202	80	121	20			
1	C	21	Total	C	N	O	P	0	0	0
			423	202	80	121	20			

- Molecule 2 is SILVER ION (CCD ID: AG) (formula: Ag) (labeled as "Ligand of Interest" by depositor).

Mol	Chain	Residues	Atoms		ZeroOcc	AltConf
2	A	16	Total	Ag	0	0
			16	16		
2	C	16	Total	Ag	0	0
			16	16		

- Molecule 3 is CHLORIDE ION (CCD ID: CL) (formula: Cl) (labeled as "Ligand of Interest" by depositor).

Mol	Chain	Residues	Atoms		ZeroOcc	AltConf
3	A	2	Total	Cl	0	0
			2	2		
3	C	2	Total	Cl	0	0
			2	2		

- Molecule 4 is water.

Mol	Chain	Residues	Atoms		ZeroOcc	AltConf
4	A	19	Total	O	0	0
			19	19		
4	C	16	Total	O	0	0
			16	16		

### 3 Residue-property plots [i](#)

These plots are drawn for all protein, RNA, DNA and oligosaccharide chains in the entry. The first graphic for a chain summarises the proportions of the various outlier classes displayed in the second graphic. The second graphic shows the sequence view annotated by issues in geometry and electron density. Residues are color-coded according to the number of geometric quality criteria for which they contain at least one outlier: green = 0, yellow = 1, orange = 2 and red = 3 or more. A red dot above a residue indicates a poor fit to the electron density ( $RSRZ > 2$ ). Stretches of 2 or more consecutive residues without any outlier are shown as a green connector. Residues present in the sample, but not in the model, are shown in grey.

- Molecule 1: DNA (5'-D(\*CP\*AP\*CP\*CP\*TP\*AP\*GP\*CP\*GP\*AP\*TP\*CP\*AP\*CP\*CP\*TP\*AP\*GP\*CP\*GP\*A)-3')

Chain A: 

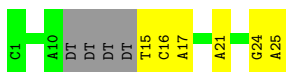

- Molecule 1: DNA (5'-D(\*CP\*AP\*CP\*CP\*TP\*AP\*GP\*CP\*GP\*AP\*TP\*CP\*AP\*CP\*CP\*TP\*AP\*GP\*CP\*GP\*A)-3')

Chain C: 

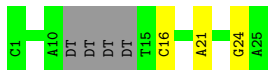

## 4 Data and refinement statistics

Property	Value	Source
Space group	P 4	Depositor
Cell constants a, b, c, $\alpha$ , $\beta$ , $\gamma$	77.05Å 77.05Å 21.51Å 90.00° 90.00° 90.00°	Depositor
Resolution (Å)	38.52 – 2.00 38.52 – 2.00	Depositor EDS
% Data completeness (in resolution range)	99.3 (38.52-2.00) 99.6 (38.52-2.00)	Depositor EDS
$R_{merge}$	0.09	Depositor
$R_{sym}$	(Not available)	Depositor
$\langle I/\sigma(I) \rangle$ <sup>1</sup>	4.67 (at 2.00Å)	Xtrriage
Refinement program	PHENIX (1.20.1_4487: ???)	Depositor
R, $R_{free}$	0.135 , 0.162 0.137 , 0.163	Depositor DCC
$R_{free}$ test set	880 reflections (9.84%)	wwPDB-VP
Wilson B-factor (Å <sup>2</sup> )	13.8	Xtrriage
Anisotropy	0.206	Xtrriage
Bulk solvent $k_{sol}$ (e/Å <sup>3</sup> ), $B_{sol}$ (Å <sup>2</sup> )	0.42 , 30.0	EDS
L-test for twinning <sup>2</sup>	$\langle  L  \rangle = 0.50$ , $\langle L^2 \rangle = 0.33$	Xtrriage
Estimated twinning fraction	0.486 for h,-k,-l	Xtrriage
$F_o, F_c$ correlation	0.98	EDS
Total number of atoms	917	wwPDB-VP
Average B, all atoms (Å <sup>2</sup> )	33.0	wwPDB-VP

Xtrriage's analysis on translational NCS is as follows: *The largest off-origin peak in the Patterson function is 13.30% of the height of the origin peak. No significant pseudotranslation is detected.*

<sup>1</sup>Intensities estimated from amplitudes.

<sup>2</sup>Theoretical values of  $\langle |L| \rangle$ ,  $\langle L^2 \rangle$  for acentric reflections are 0.5, 0.333 respectively for untwinned datasets, and 0.375, 0.2 for perfectly twinned datasets.

## 5 Model quality

### 5.1 Standard geometry

Bond lengths and bond angles in the following residue types are not validated in this section: AG, CL

The Z score for a bond length (or angle) is the number of standard deviations the observed value is removed from the expected value. A bond length (or angle) with  $|Z| > 5$  is considered an outlier worth inspection. RMSZ is the root-mean-square of all Z scores of the bond lengths (or angles).

Mol	Chain	Bond lengths		Bond angles	
		RMSZ	# Z  >5	RMSZ	# Z  >5
1	A	0.45	0/473	0.88	0/724
1	C	0.45	0/473	0.86	0/724
All	All	0.45	0/946	0.87	0/1448

There are no bond length outliers.

There are no bond angle outliers.

There are no chirality outliers.

There are no planarity outliers.

### 5.2 Too-close contacts

In the following table, the Non-H and H(model) columns list the number of non-hydrogen atoms and hydrogen atoms in the chain respectively. The H(added) column lists the number of hydrogen atoms added and optimized by MolProbity. The Clashes column lists the number of clashes within the asymmetric unit, whereas Symm-Clashes lists symmetry-related clashes.

Mol	Chain	Non-H	H(model)	H(added)	Clashes	Symm-Clashes
1	A	423	0	235	4	0
1	C	423	0	235	2	0
2	A	16	0	0	0	0
2	C	16	0	0	0	0
3	A	2	0	0	0	0
3	C	2	0	0	0	0
4	A	19	0	0	0	0
4	C	16	0	0	0	0
All	All	917	0	470	6	0

The all-atom clashscore is defined as the number of clashes found per 1000 atoms (including hydrogen atoms). The all-atom clashscore for this structure is 4.

All (6) close contacts within the same asymmetric unit are listed below, sorted by their clash magnitude.

Atom-1	Atom-2	Interatomic distance (Å)	Clash overlap (Å)
1:A:15:DT:H4'	1:A:16:DC:H5''	1.86	0.56
1:C:21:DA:OP2	1:C:21:DA:H8	1.91	0.53
1:A:21:DA:OP2	1:A:21:DA:H8	1.97	0.46
1:A:16:DC:H4'	1:A:17:DA:O5'	2.17	0.44
1:A:24:DG:N2	1:A:25:DA:H62	2.16	0.43
1:C:16:DC:H2''	1:C:24:DG:C8	2.54	0.42

There are no symmetry-related clashes.

### 5.3 Torsion angles [i](#)

#### 5.3.1 Protein backbone [i](#)

There are no protein molecules in this entry.

#### 5.3.2 Protein sidechains [i](#)

There are no protein molecules in this entry.

#### 5.3.3 RNA [i](#)

There are no RNA molecules in this entry.

### 5.4 Non-standard residues in protein, DNA, RNA chains [i](#)

There are no non-standard protein/DNA/RNA residues in this entry.

### 5.5 Carbohydrates [i](#)

There are no oligosaccharides in this entry.

### 5.6 Ligand geometry [i](#)

Of 36 ligands modelled in this entry, 36 are monoatomic - leaving 0 for Mogul analysis.

There are no bond length outliers.

There are no bond angle outliers.

There are no chirality outliers.

There are no torsion outliers.

There are no ring outliers.

No monomer is involved in short contacts.

## 5.7 Other polymers

There are no such residues in this entry.

## 5.8 Polymer linkage issues

There are no chain breaks in this entry.

## 6 Fit of model and data [i](#)

### 6.1 Protein, DNA and RNA chains [i](#)

In the following table, the column labelled '#RSRZ > 2' contains the number (and percentage) of RSRZ outliers, followed by percent RSRZ outliers for the chain as percentile scores relative to all X-ray entries and entries of similar resolution. The OWAB column contains the minimum, median, 95<sup>th</sup> percentile and maximum values of the occupancy-weighted average B-factor per residue. The column labelled 'Q < 0.9' lists the number of (and percentage) of residues with an average occupancy less than 0.9.

Mol	Chain	Analysed	<RSRZ>	#RSRZ>2	OWAB(Å <sup>2</sup> )	Q<0.9
1	A	21/25 (84%)	-1.11	0 <a href="#">100</a> <a href="#">100</a>	28, 33, 37, 48	0
1	C	21/25 (84%)	-1.16	0 <a href="#">100</a> <a href="#">100</a>	28, 33, 38, 49	0
All	All	42/50 (84%)	-1.13	0 <a href="#">100</a> <a href="#">100</a>	28, 33, 40, 49	0

There are no RSRZ outliers to report.

### 6.2 Non-standard residues in protein, DNA, RNA chains [i](#)

There are no non-standard protein/DNA/RNA residues in this entry.

### 6.3 Carbohydrates [i](#)

There are no oligosaccharides in this entry.

### 6.4 Ligands [i](#)

In the following table, the Atoms column lists the number of modelled atoms in the group and the number defined in the chemical component dictionary. The B-factors column lists the minimum, median, 95<sup>th</sup> percentile and maximum values of B factors of atoms in the group. The column labelled 'Q < 0.9' lists the number of atoms with occupancy less than 0.9.

Mol	Type	Chain	Res	Atoms	RSCC	RSR	B-factors(Å <sup>2</sup> )	Q<0.9
3	CL	A	117	1/1	0.99	0.05	24,24,24,24	0
3	CL	C	117	1/1	0.99	0.04	24,24,24,24	0
2	AG	A	103	1/1	1.00	0.01	20,20,20,20	0
2	AG	A	104	1/1	1.00	0.01	21,21,21,21	0
2	AG	A	105	1/1	1.00	0.01	21,21,21,21	0
2	AG	A	106	1/1	1.00	0.01	20,20,20,20	0
2	AG	A	107	1/1	1.00	0.01	21,21,21,21	0

*Continued on next page...*

*Continued from previous page...*

Mol	Type	Chain	Res	Atoms	RSCC	RSR	B-factors( $\text{\AA}^2$ )	Q<0.9
2	AG	A	108	1/1	1.00	0.01	21,21,21,21	0
2	AG	A	109	1/1	1.00	0.01	22,22,22,22	0
2	AG	A	110	1/1	1.00	0.01	21,21,21,21	0
2	AG	A	111	1/1	1.00	0.01	22,22,22,22	0
2	AG	A	112	1/1	1.00	0.00	22,22,22,22	0
2	AG	A	113	1/1	1.00	0.01	23,23,23,23	0
2	AG	A	114	1/1	1.00	0.01	23,23,23,23	0
2	AG	A	115	1/1	1.00	0.01	24,24,24,24	0
2	AG	A	116	1/1	1.00	0.01	24,24,24,24	0
2	AG	C	101	1/1	1.00	0.01	24,24,24,24	0
2	AG	C	102	1/1	1.00	0.00	24,24,24,24	0
2	AG	C	103	1/1	1.00	0.01	23,23,23,23	0
2	AG	C	104	1/1	1.00	0.00	24,24,24,24	0
2	AG	C	105	1/1	1.00	0.01	22,22,22,22	0
2	AG	C	106	1/1	1.00	0.01	21,21,21,21	0
2	AG	C	107	1/1	1.00	0.01	22,22,22,22	0
2	AG	C	108	1/1	1.00	0.00	21,21,21,21	0
2	AG	C	109	1/1	1.00	0.01	21,21,21,21	0
2	AG	C	110	1/1	1.00	0.01	21,21,21,21	0
2	AG	C	111	1/1	1.00	0.01	22,22,22,22	0
2	AG	C	112	1/1	1.00	0.01	20,20,20,20	0
2	AG	C	113	1/1	1.00	0.01	20,20,20,20	0
2	AG	C	114	1/1	1.00	0.01	21,21,21,21	0
2	AG	C	115	1/1	1.00	0.01	23,23,23,23	0
2	AG	C	116	1/1	1.00	0.01	21,21,21,21	0
2	AG	A	101	1/1	1.00	0.01	22,22,22,22	0
3	CL	A	118	1/1	1.00	0.05	22,22,22,22	0
2	AG	A	102	1/1	1.00	0.01	21,21,21,21	0
3	CL	C	118	1/1	1.00	0.03	24,24,24,24	0

The following is a graphical depiction of the model fit to experimental electron density of all instances of the Ligand of Interest. In addition, ligands with molecular weight > 250 and outliers as shown on the geometry validation Tables will also be included. Each fit is shown from different orientation to approximate a three-dimensional view.

**Electron density around CL A 117:**

$2mF_o-DF_c$  (at 0.7 rmsd) in gray  
 $mF_o-DF_c$  (at 3 rmsd) in purple (negative)  
and green (positive)

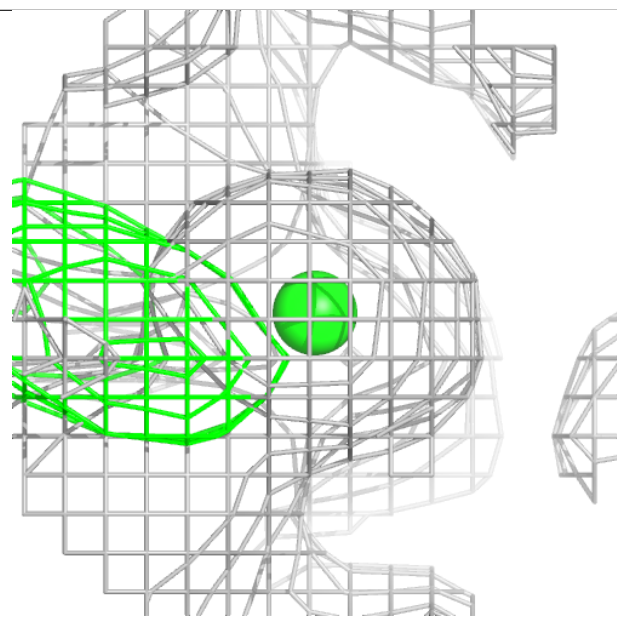
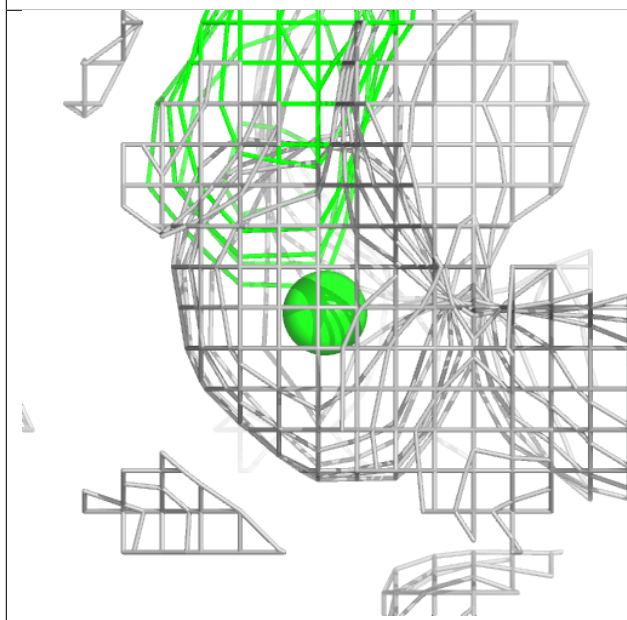
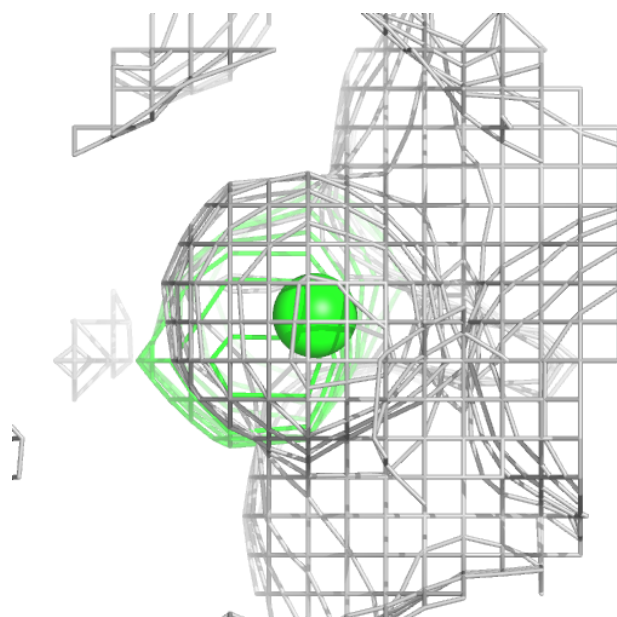

**Electron density around CL C 117:**

$2mF_o-DF_c$  (at 0.7 rmsd) in gray  
 $mF_o-DF_c$  (at 3 rmsd) in purple (negative)  
and green (positive)

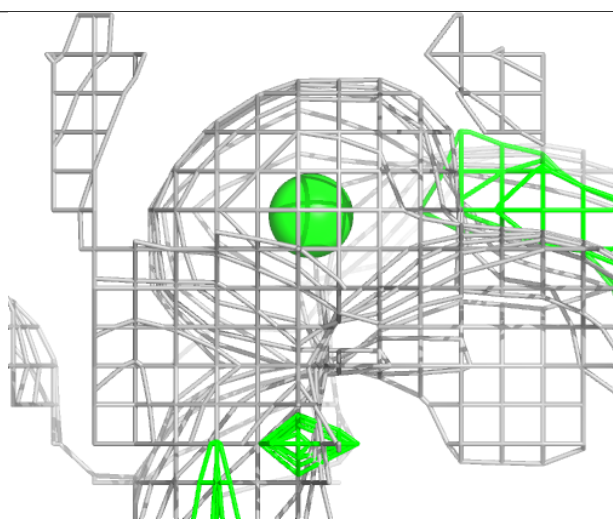
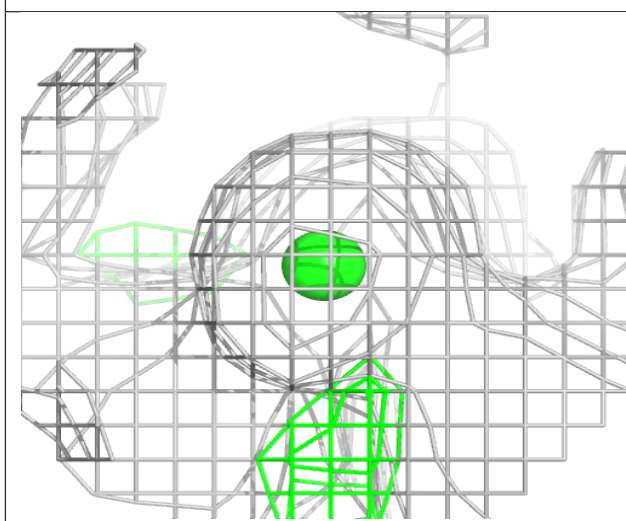
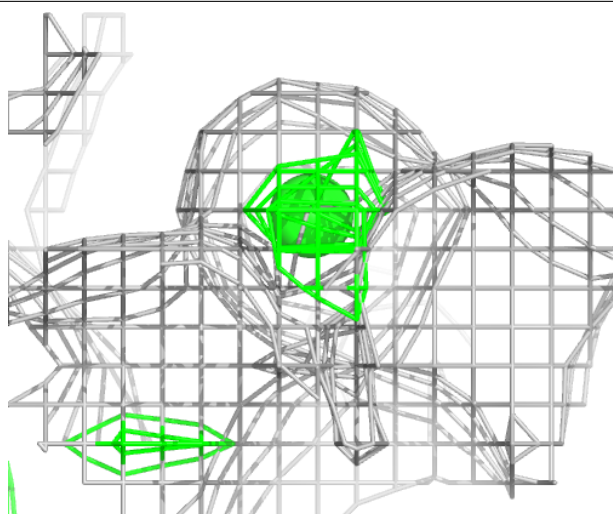

**Electron density around AG A 103:**

$2mF_o-DF_c$  (at 0.7 rmsd) in gray  
 $mF_o-DF_c$  (at 3 rmsd) in purple (negative)  
and green (positive)

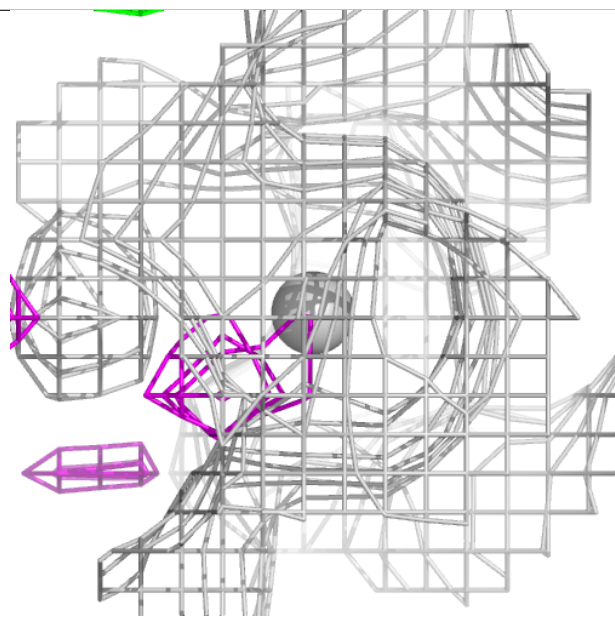
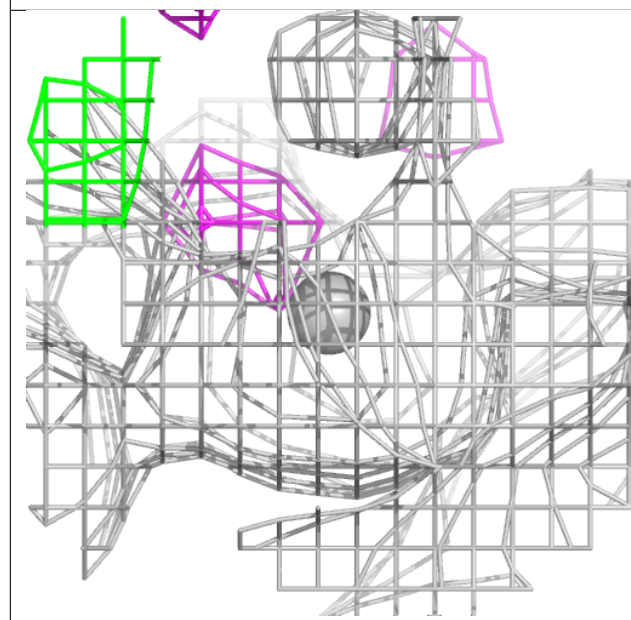
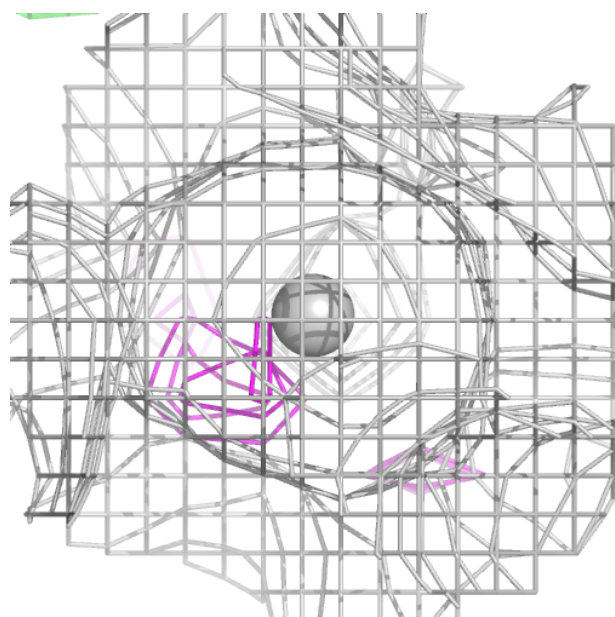

**Electron density around AG A 104:**

$2mF_o-DF_c$  (at 0.7 rmsd) in gray  
 $mF_o-DF_c$  (at 3 rmsd) in purple (negative)  
and green (positive)

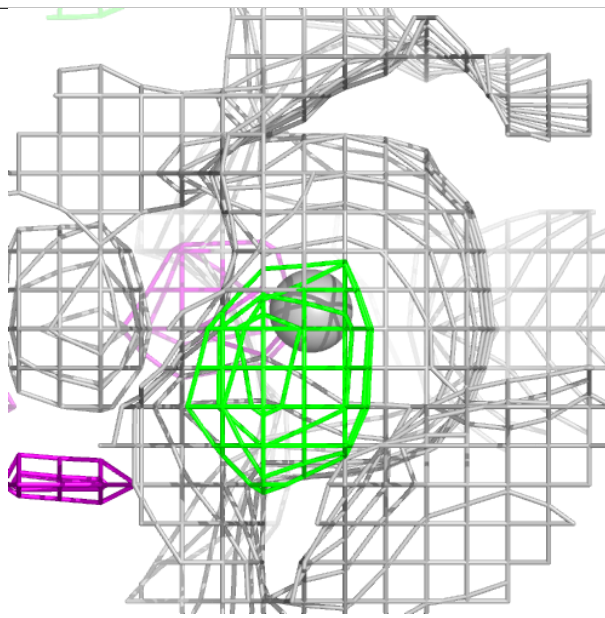
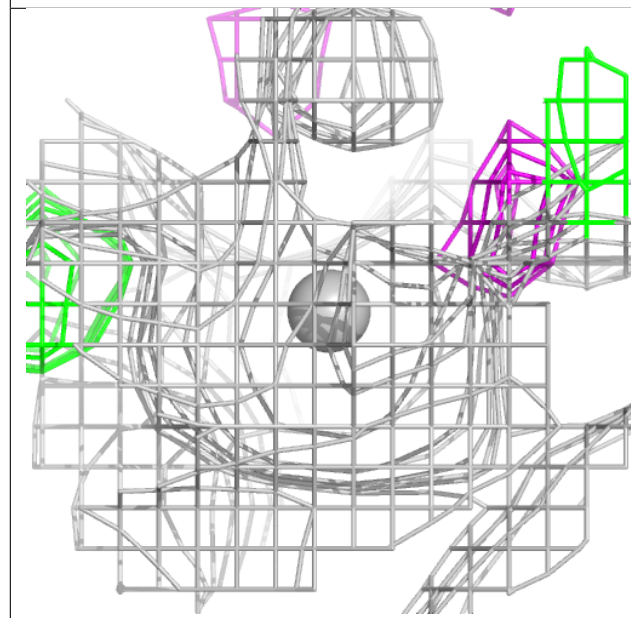
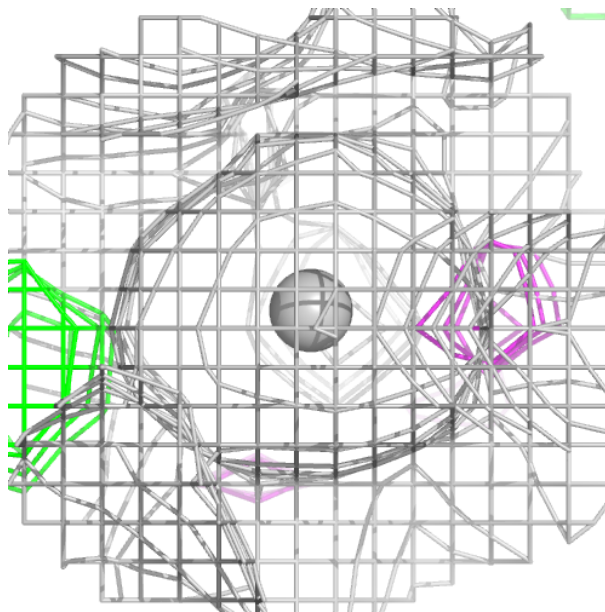

**Electron density around AG A 105:**

$2mF_o-DF_c$  (at 0.7 rmsd) in gray  
 $mF_o-DF_c$  (at 3 rmsd) in purple (negative)  
and green (positive)

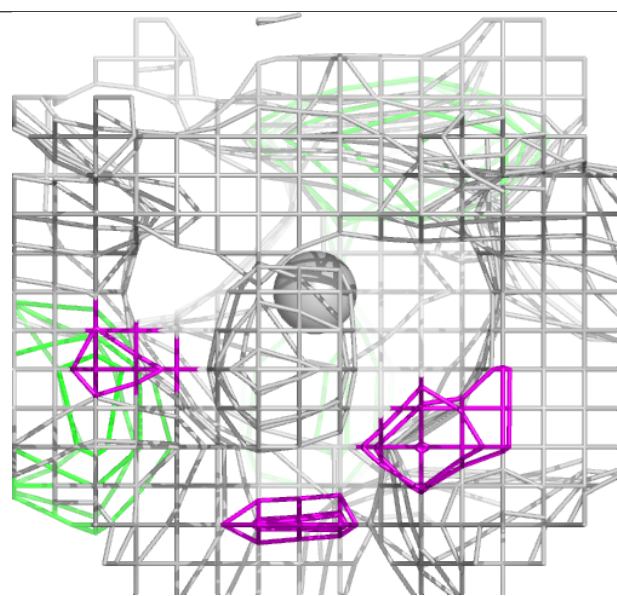
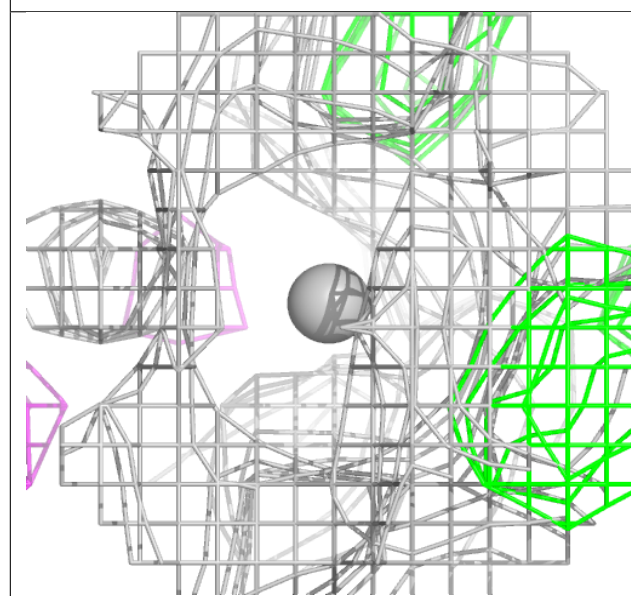
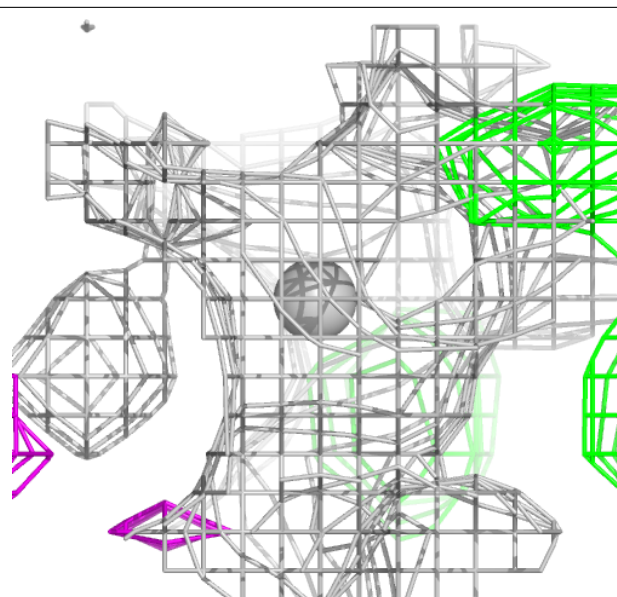

**Electron density around AG A 106:**

$2mF_o-DF_c$  (at 0.7 rmsd) in gray  
 $mF_o-DF_c$  (at 3 rmsd) in purple (negative)  
and green (positive)

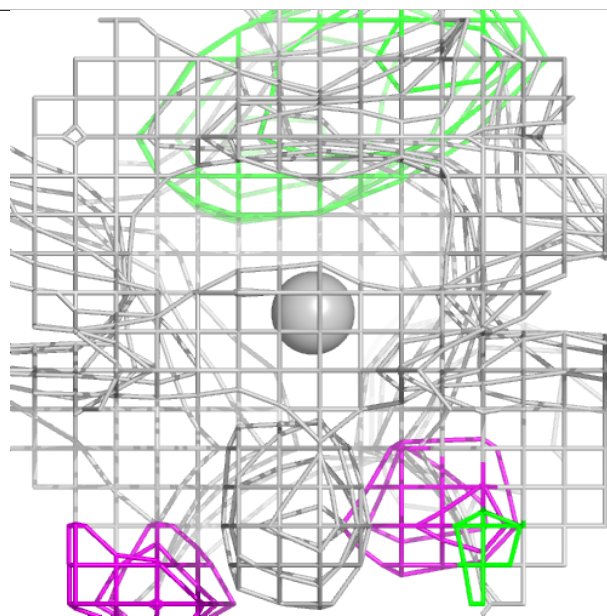
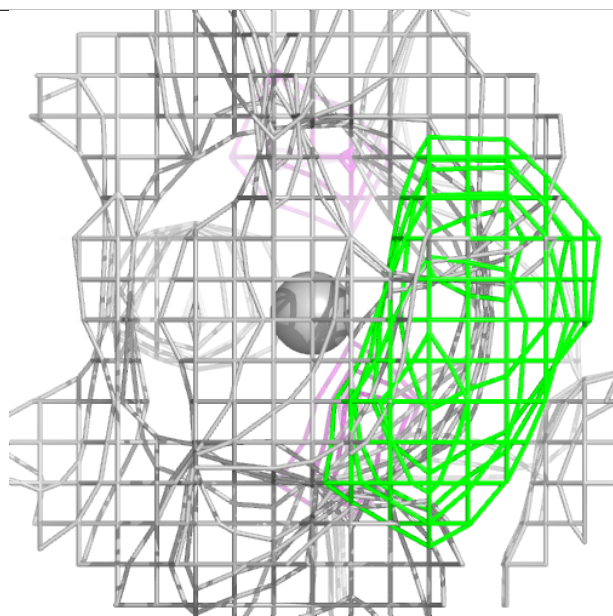
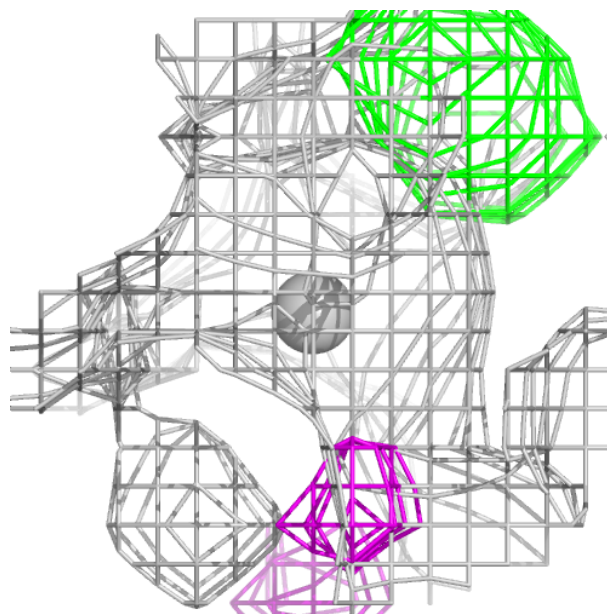

**Electron density around AG A 107:**

$2mF_o-DF_c$  (at 0.7 rmsd) in gray  
 $mF_o-DF_c$  (at 3 rmsd) in purple (negative)  
and green (positive)

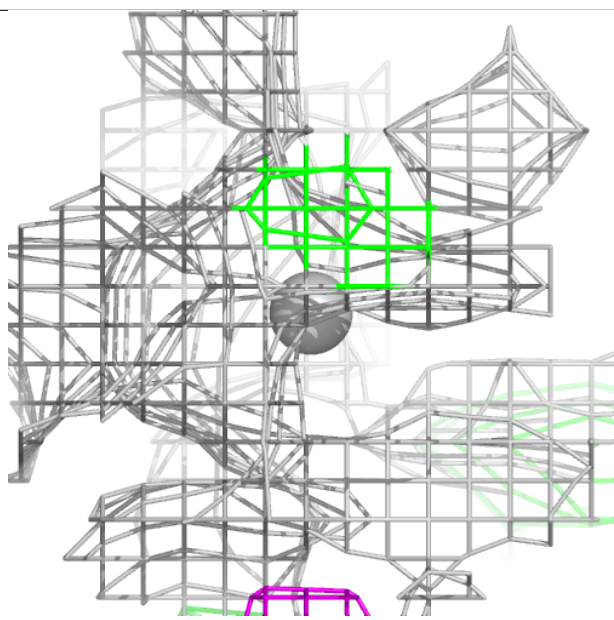
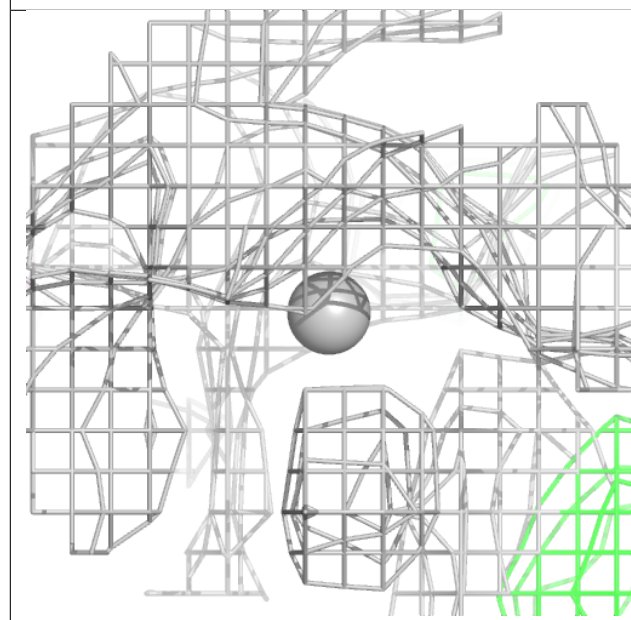
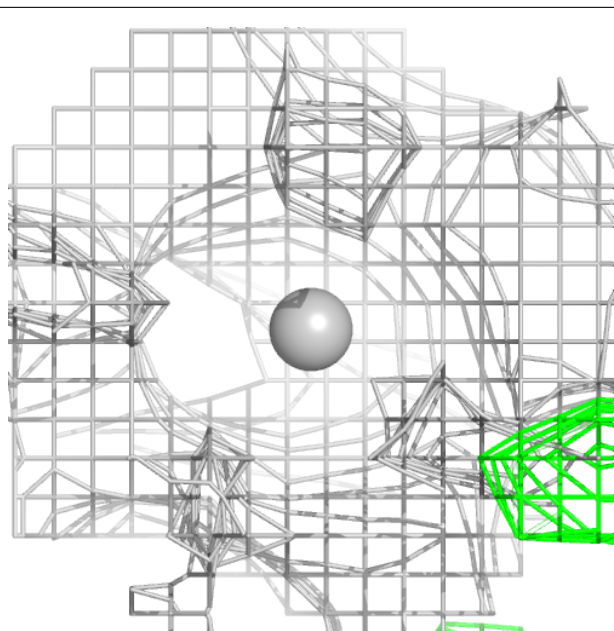

**Electron density around AG A 108:**

$2mF_o-DF_c$  (at 0.7 rmsd) in gray  
 $mF_o-DF_c$  (at 3 rmsd) in purple (negative)  
and green (positive)

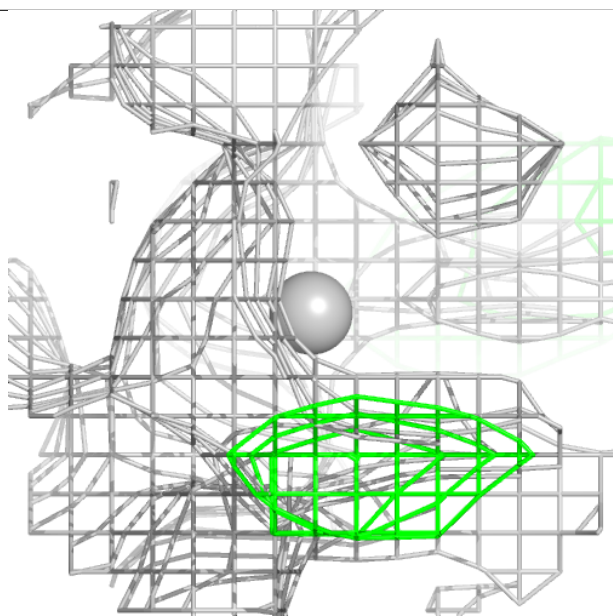
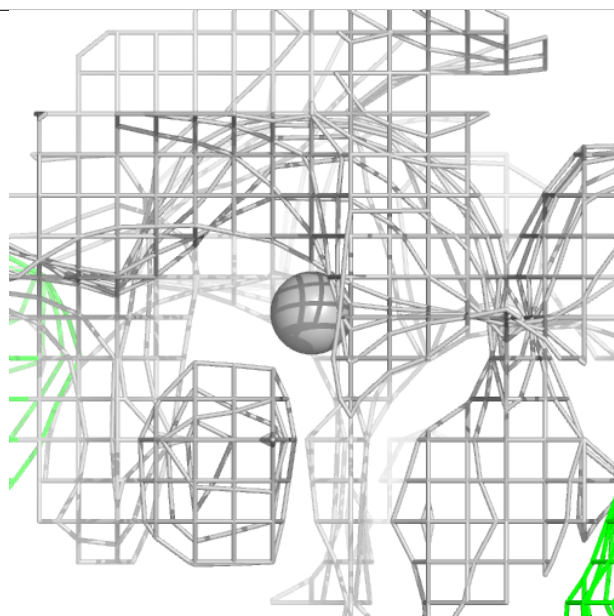
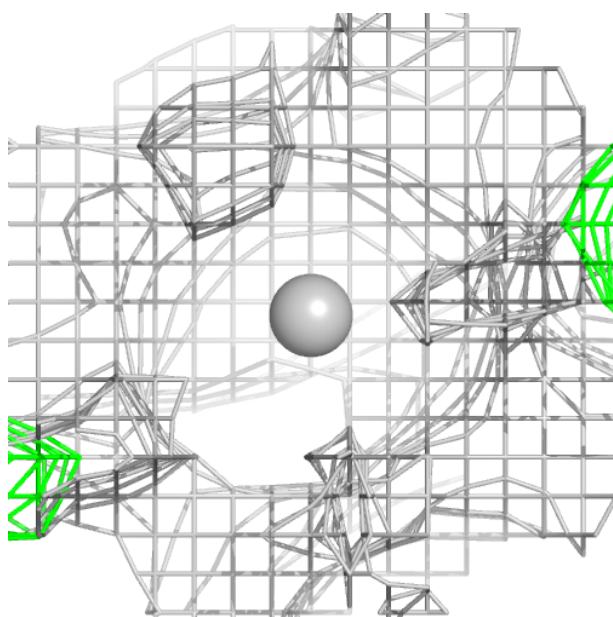

**Electron density around AG A 109:**

$2mF_o-DF_c$  (at 0.7 rmsd) in gray  
 $mF_o-DF_c$  (at 3 rmsd) in purple (negative)  
and green (positive)

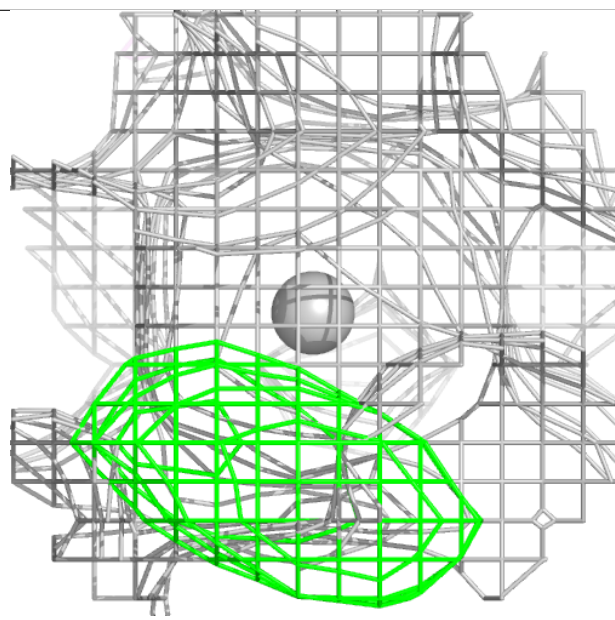
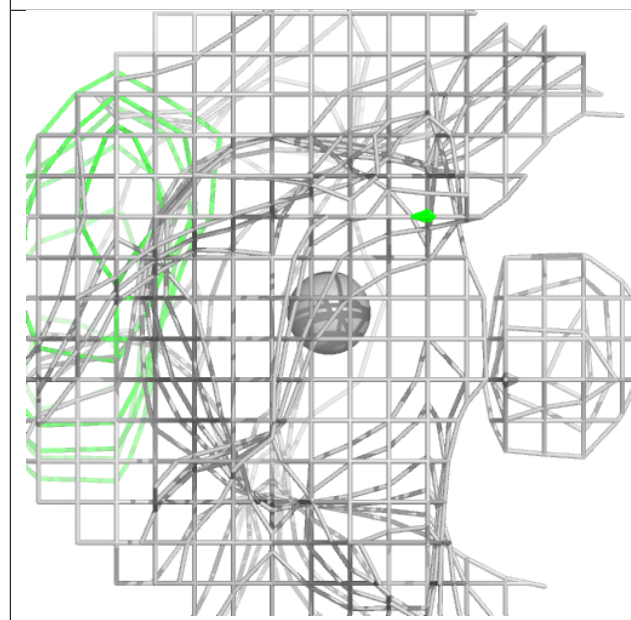
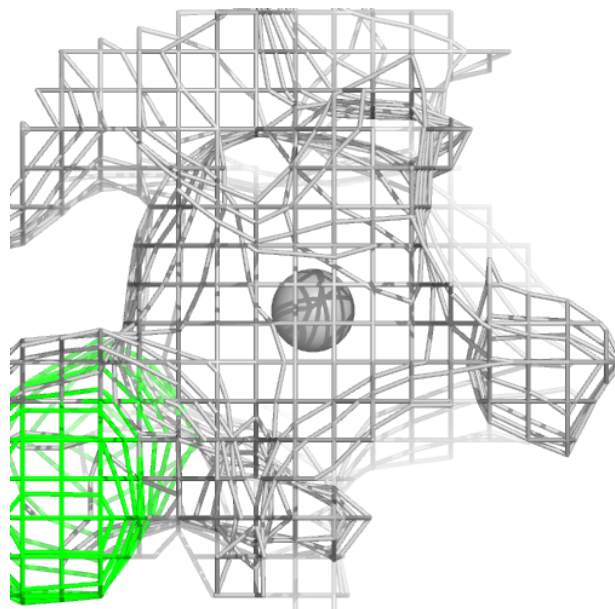

**Electron density around AG A 110:**

$2mF_o-DF_c$  (at 0.7 rmsd) in gray  
 $mF_o-DF_c$  (at 3 rmsd) in purple (negative)  
and green (positive)

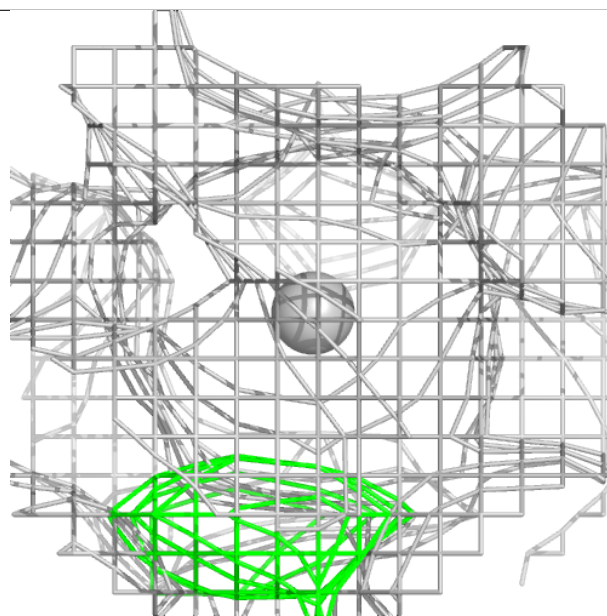
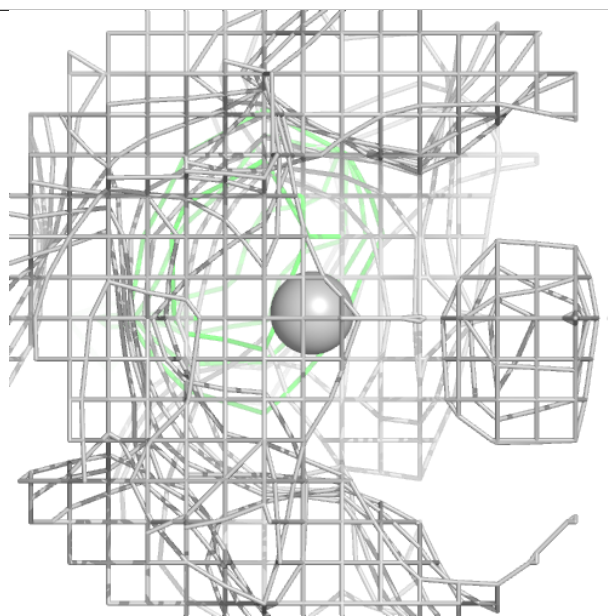
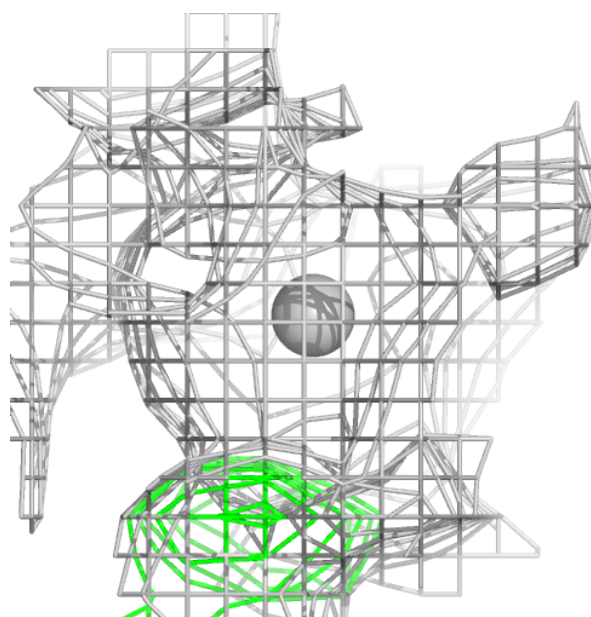

**Electron density around AG A 111:**

$2mF_o-DF_c$  (at 0.7 rmsd) in gray  
 $mF_o-DF_c$  (at 3 rmsd) in purple (negative)  
and green (positive)

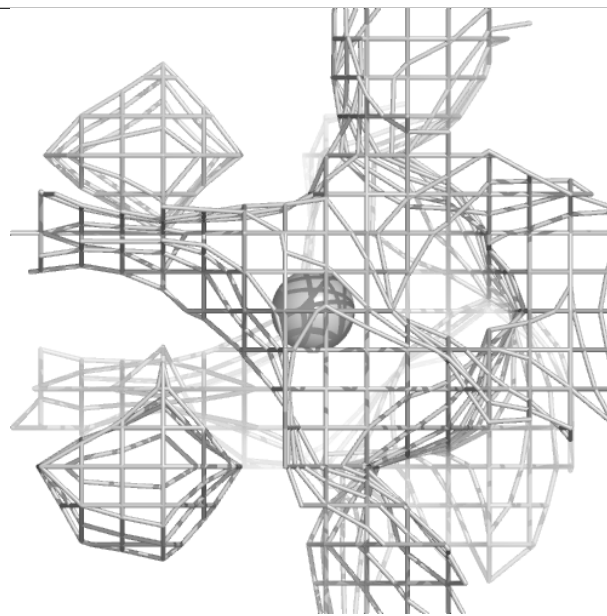
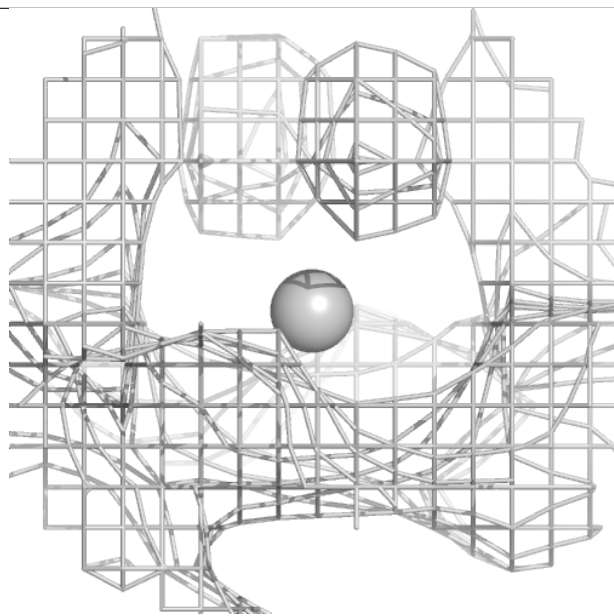
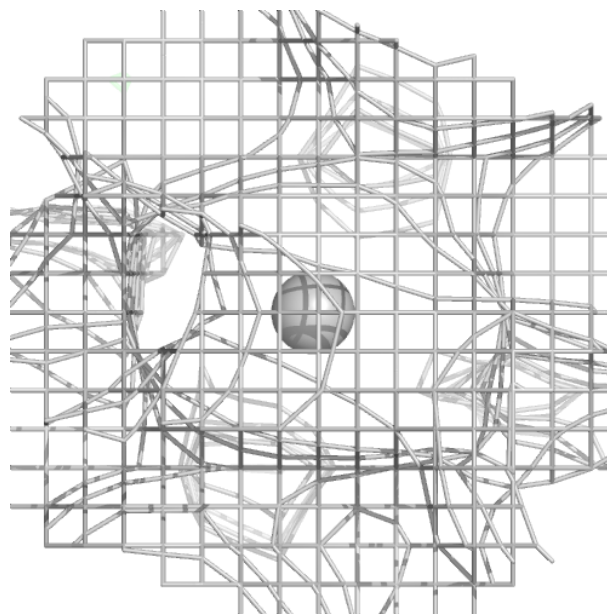

**Electron density around AG A 112:**

$2mF_o-DF_c$  (at 0.7 rmsd) in gray  
 $mF_o-DF_c$  (at 3 rmsd) in purple (negative)  
and green (positive)

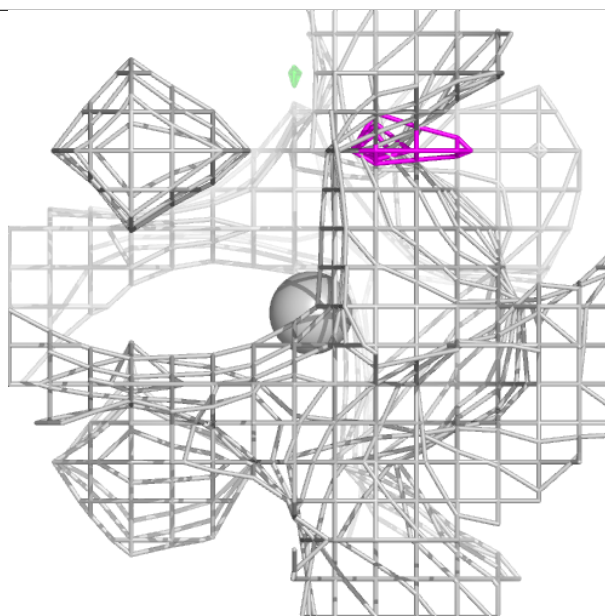
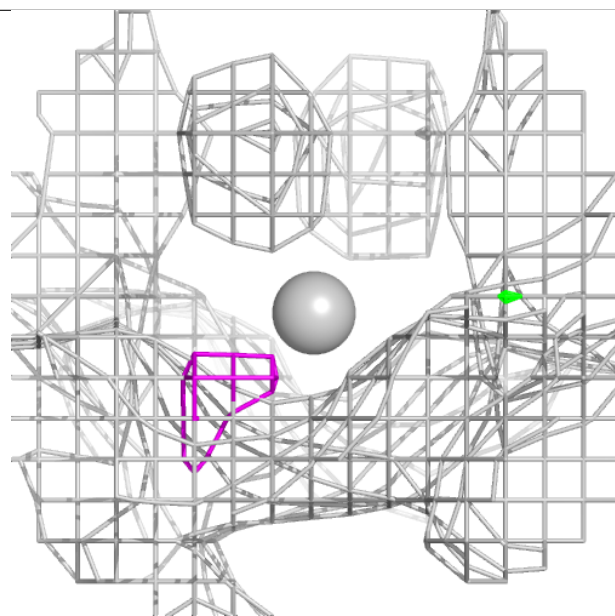
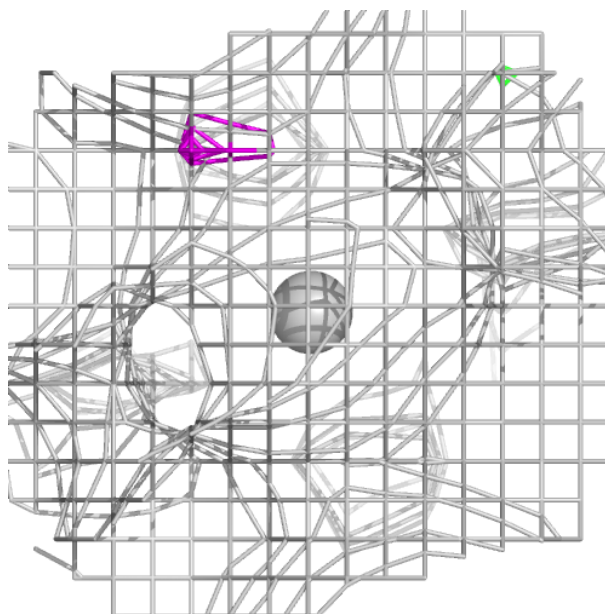

**Electron density around AG A 113:**

$2mF_o-DF_c$  (at 0.7 rmsd) in gray  
 $mF_o-DF_c$  (at 3 rmsd) in purple (negative)  
and green (positive)

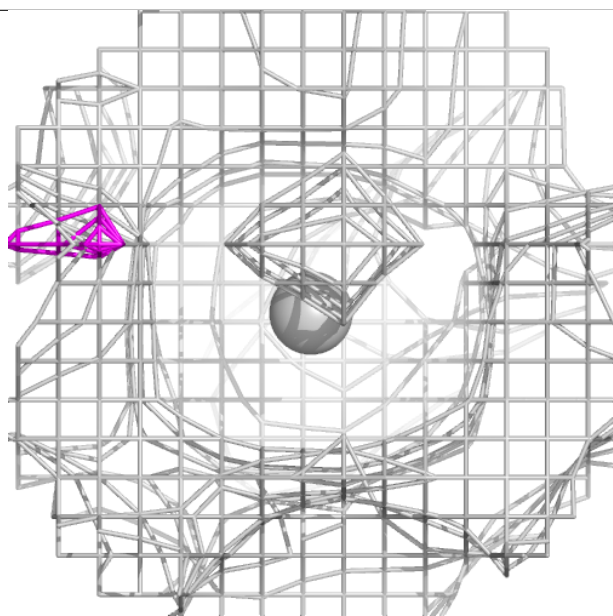
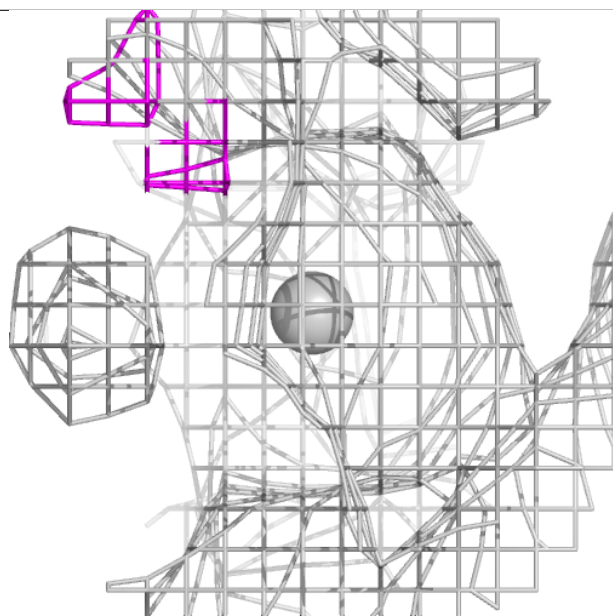
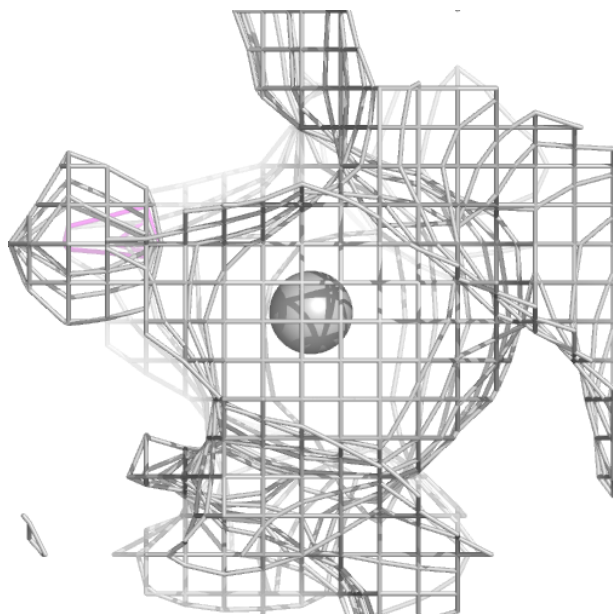

**Electron density around AG A 114:**

$2mF_o-DF_c$  (at 0.7 rmsd) in gray  
 $mF_o-DF_c$  (at 3 rmsd) in purple (negative)  
and green (positive)

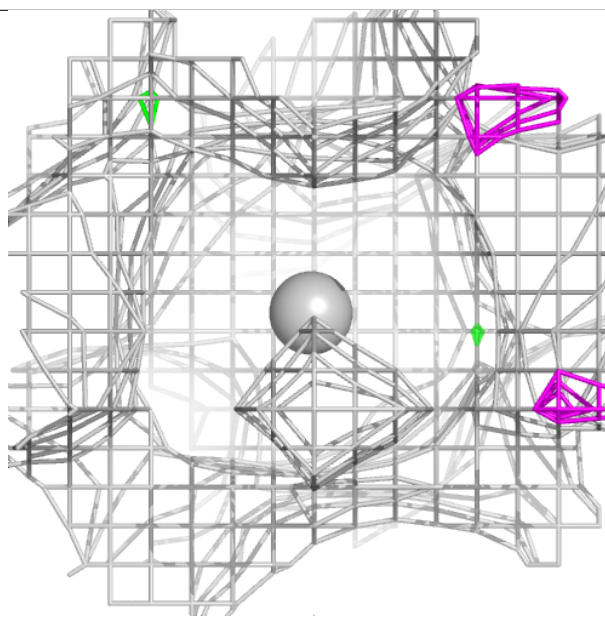
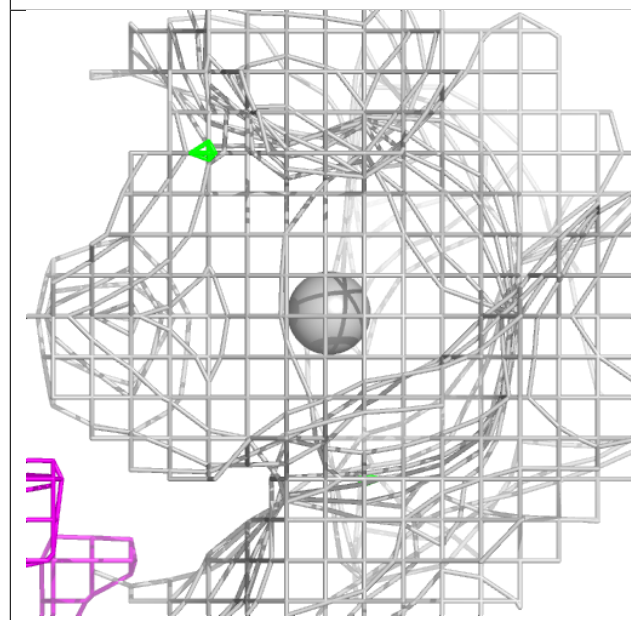
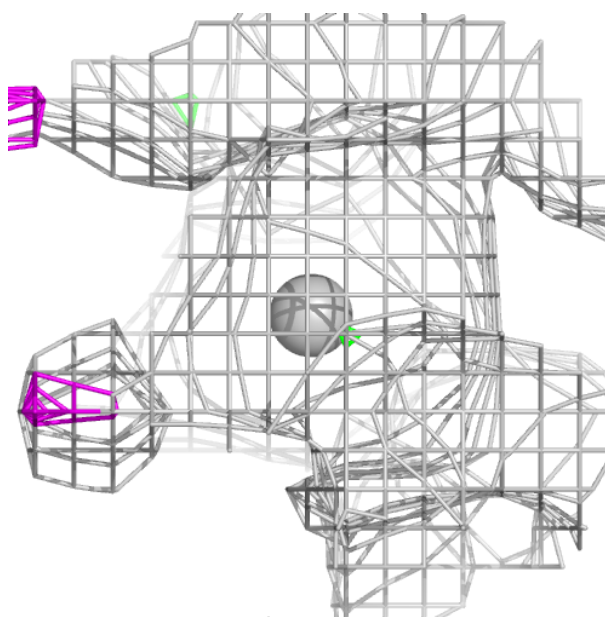

**Electron density around AG A 115:**

$2mF_o-DF_c$  (at 0.7 rmsd) in gray  
 $mF_o-DF_c$  (at 3 rmsd) in purple (negative)  
and green (positive)

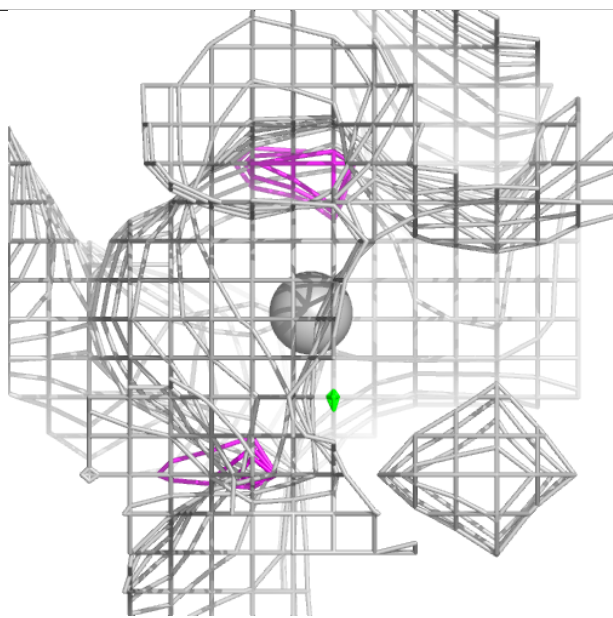
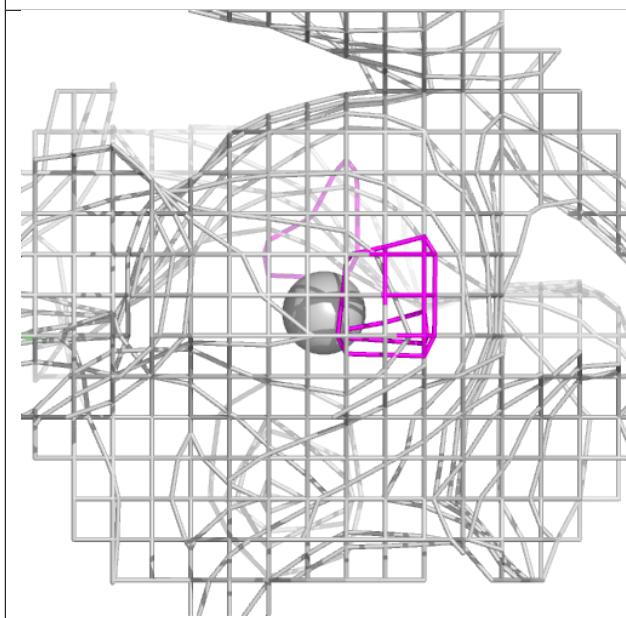
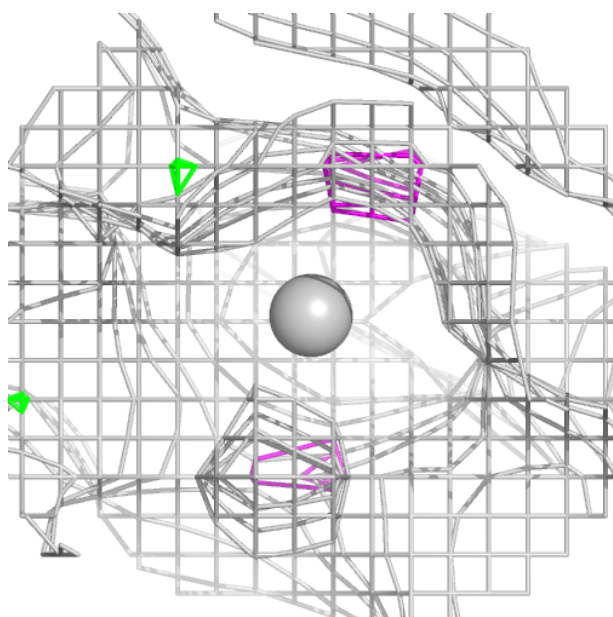

**Electron density around AG A 116:**

$2mF_o-DF_c$  (at 0.7 rmsd) in gray  
 $mF_o-DF_c$  (at 3 rmsd) in purple (negative)  
and green (positive)

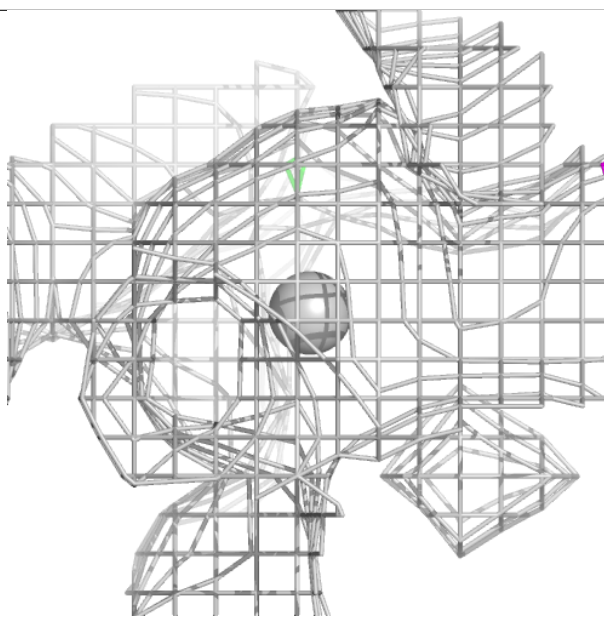
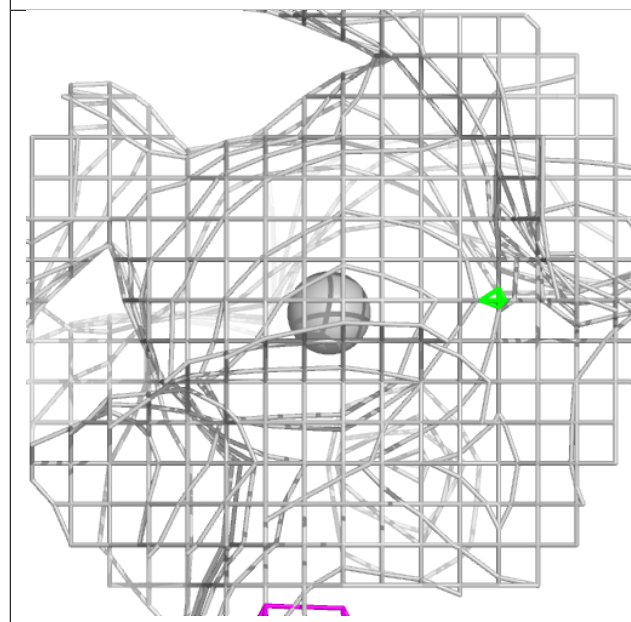
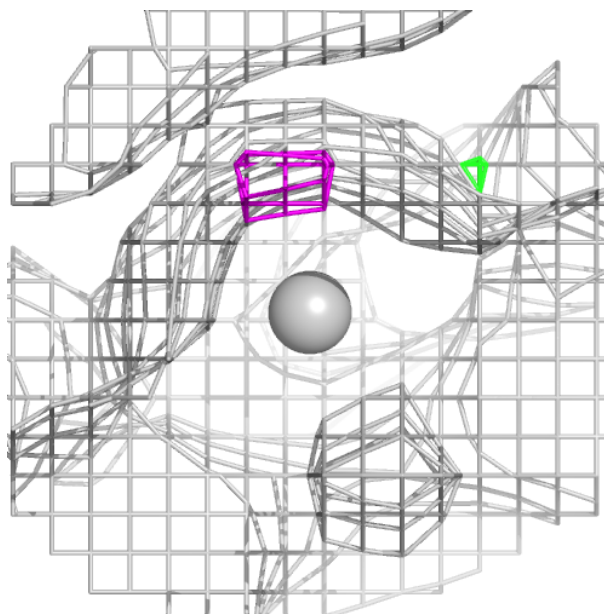

**Electron density around AG C 101:**

$2mF_o-DF_c$  (at 0.7 rmsd) in gray  
 $mF_o-DF_c$  (at 3 rmsd) in purple (negative)  
and green (positive)

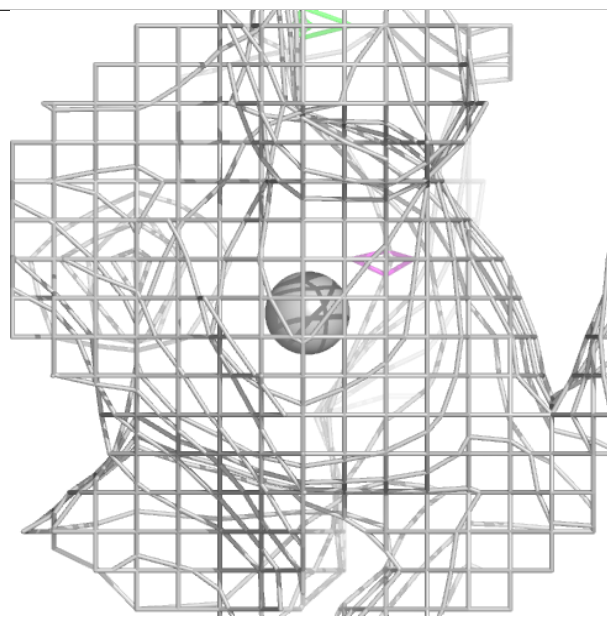
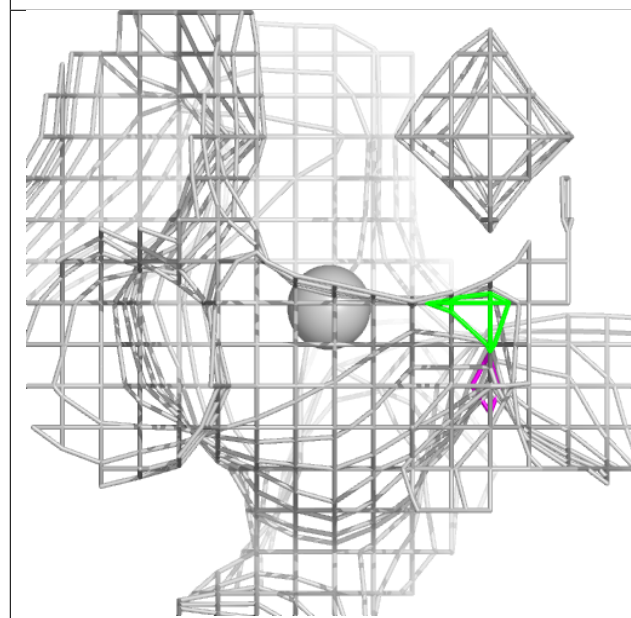
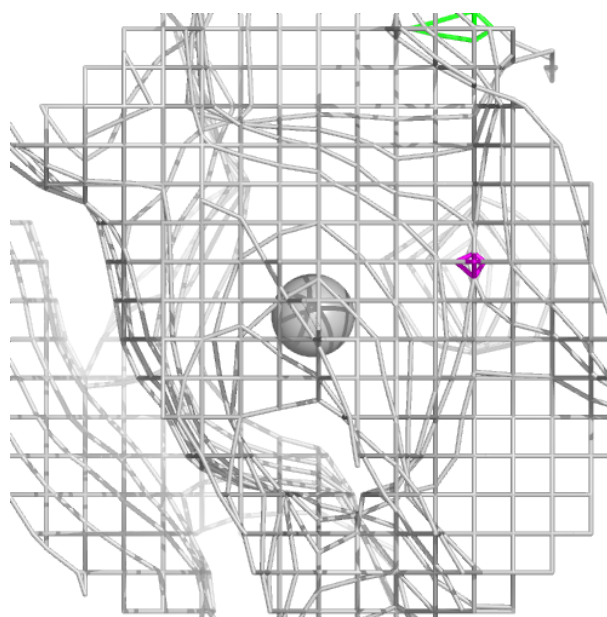

**Electron density around AG C 102:**

$2mF_o-DF_c$  (at 0.7 rmsd) in gray  
 $mF_o-DF_c$  (at 3 rmsd) in purple (negative)  
and green (positive)

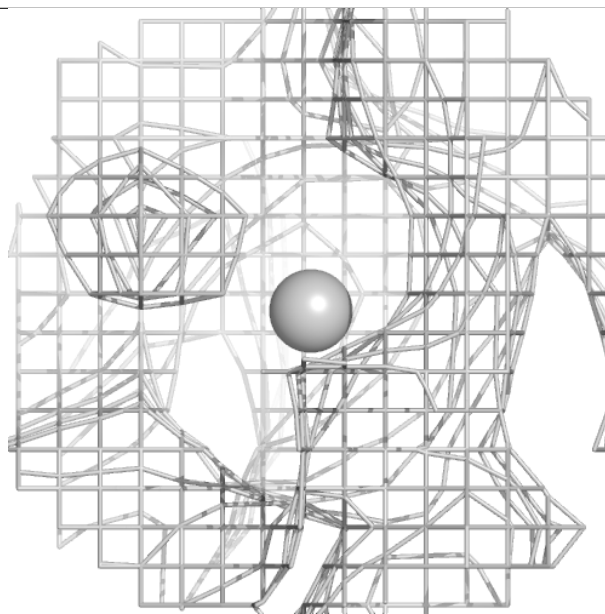
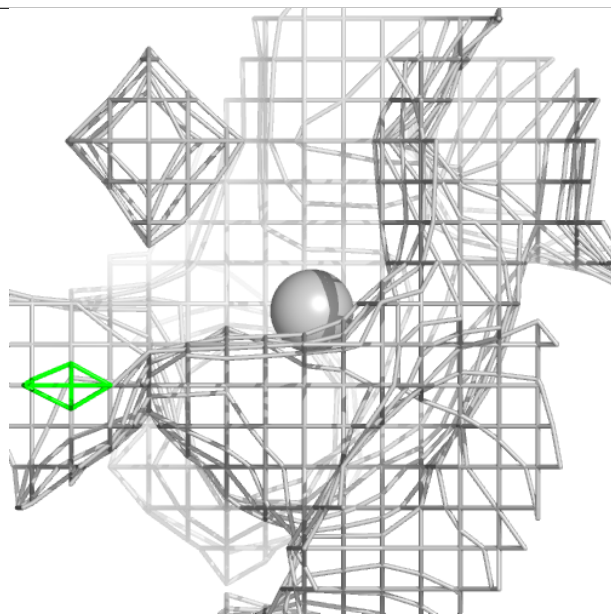
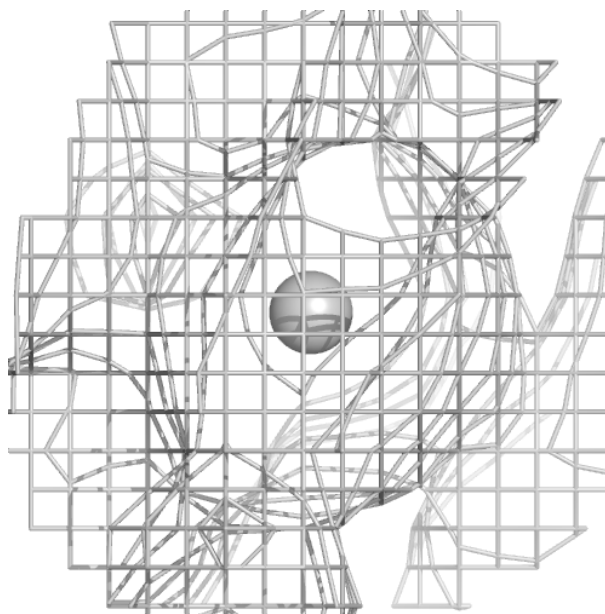

**Electron density around AG C 103:**

$2mF_o-DF_c$  (at 0.7 rmsd) in gray  
 $mF_o-DF_c$  (at 3 rmsd) in purple (negative)  
and green (positive)

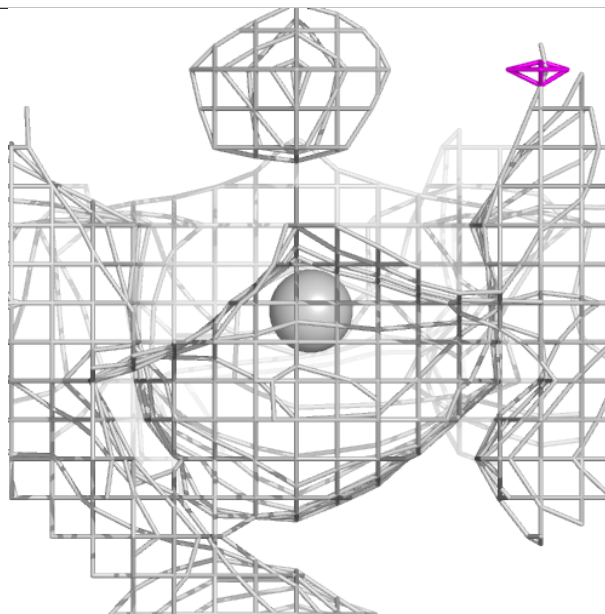
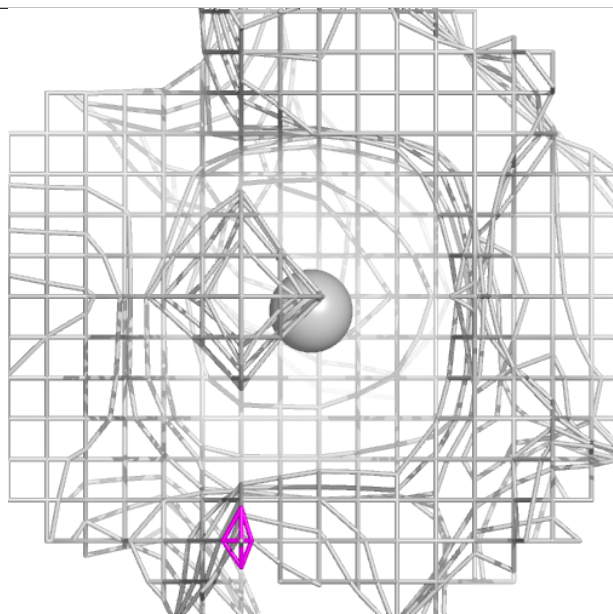
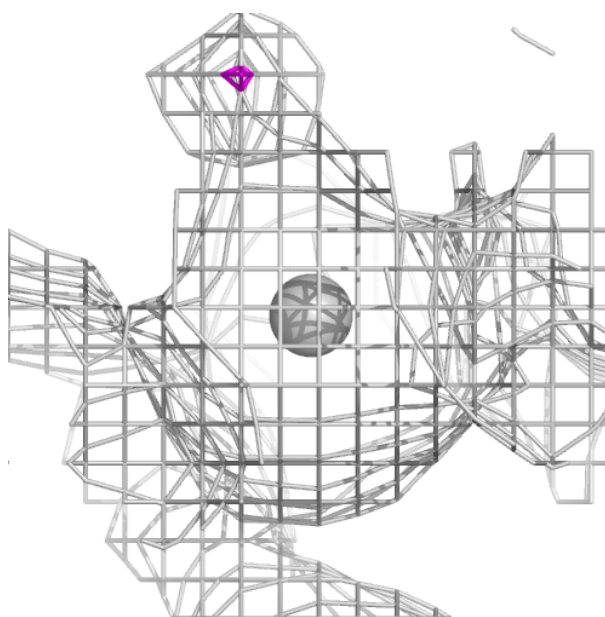

**Electron density around AG C 104:**

$2mF_o-DF_c$  (at 0.7 rmsd) in gray  
 $mF_o-DF_c$  (at 3 rmsd) in purple (negative)  
and green (positive)

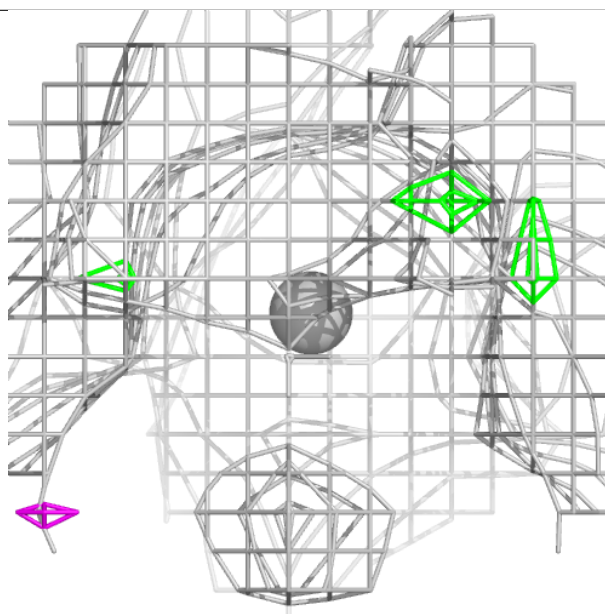
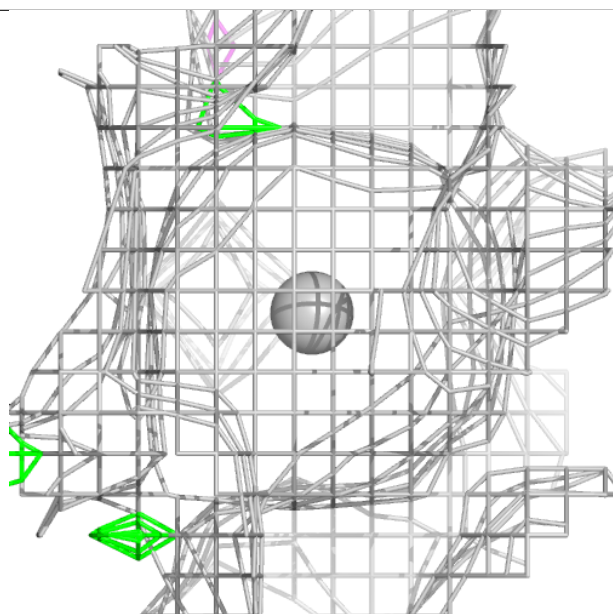
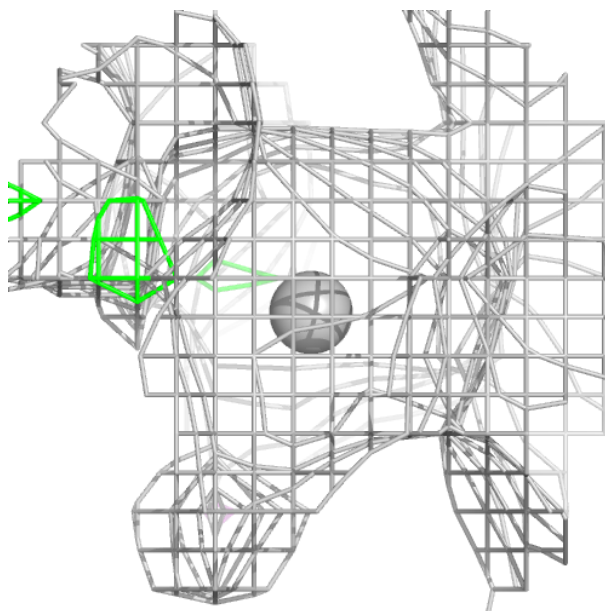

**Electron density around AG C 105:**

$2mF_o-DF_c$  (at 0.7 rmsd) in gray  
 $mF_o-DF_c$  (at 3 rmsd) in purple (negative)  
and green (positive)

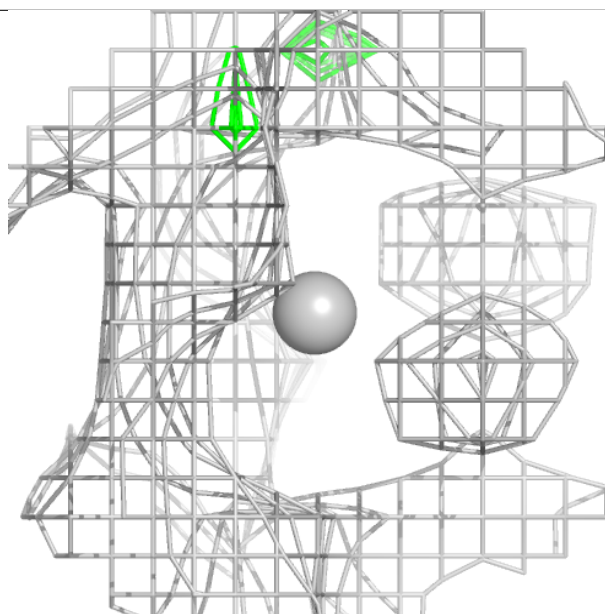
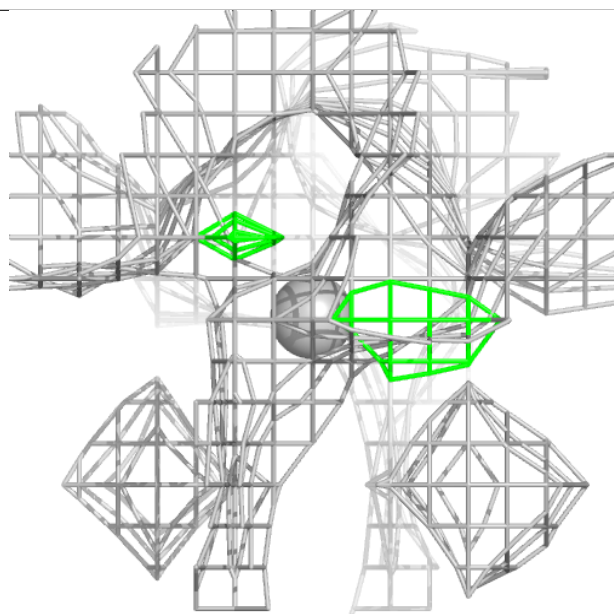
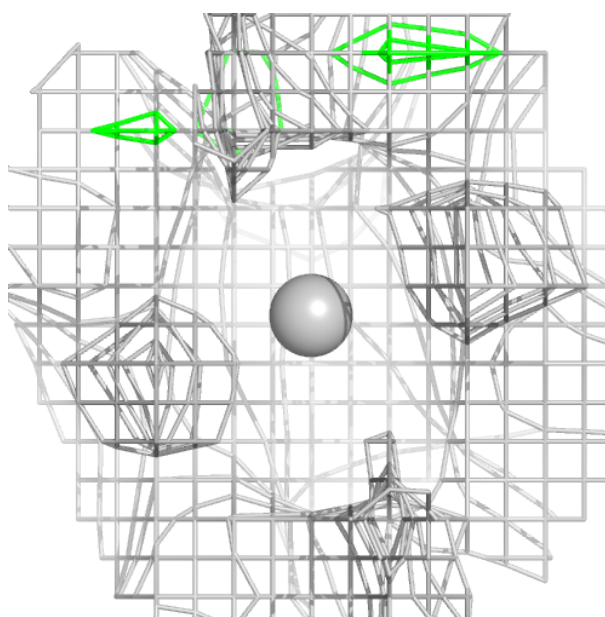

**Electron density around AG C 106:**

$2mF_o-DF_c$  (at 0.7 rmsd) in gray  
 $mF_o-DF_c$  (at 3 rmsd) in purple (negative)  
and green (positive)

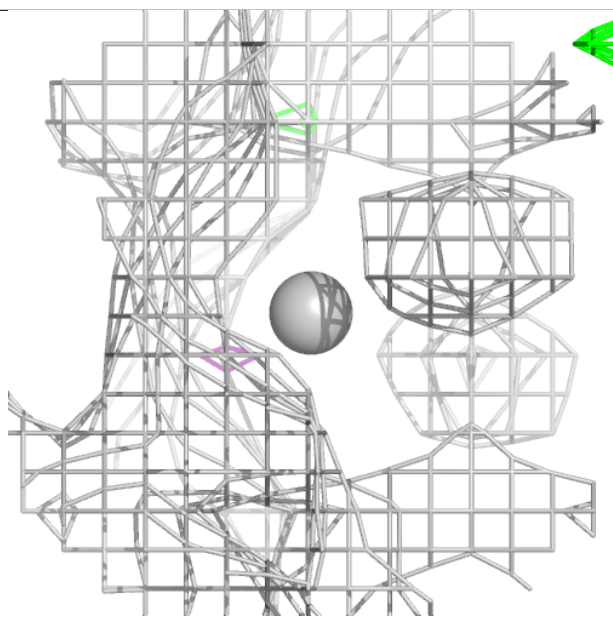
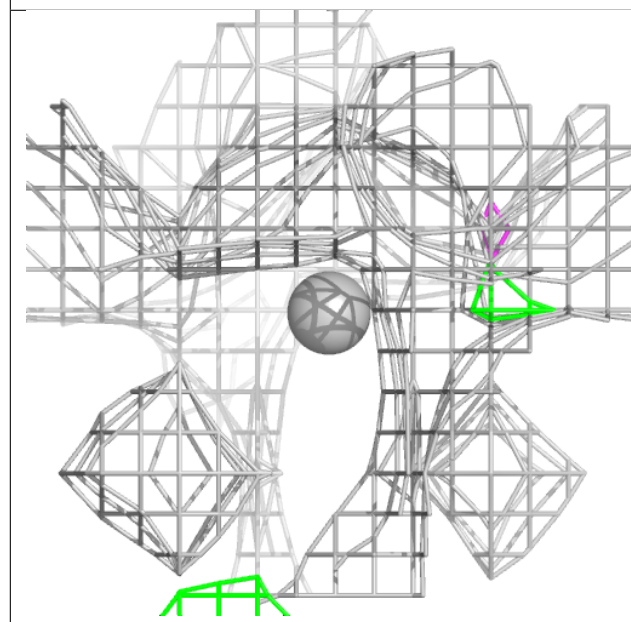
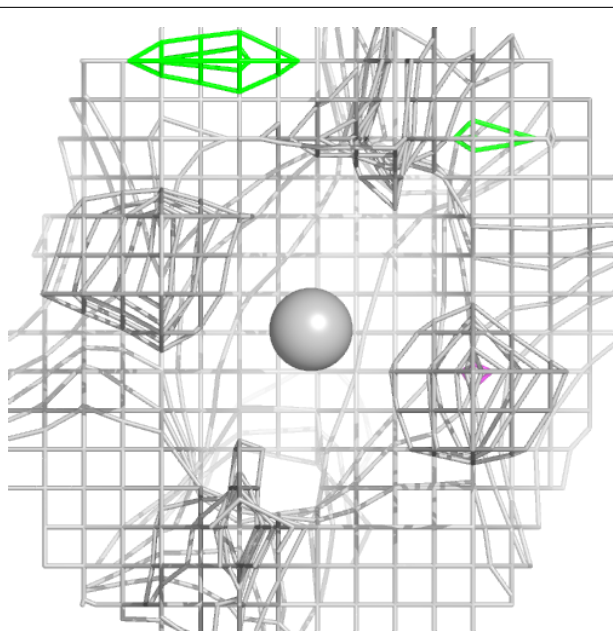

**Electron density around AG C 107:**

$2mF_o-DF_c$  (at 0.7 rmsd) in gray  
 $mF_o-DF_c$  (at 3 rmsd) in purple (negative)  
and green (positive)

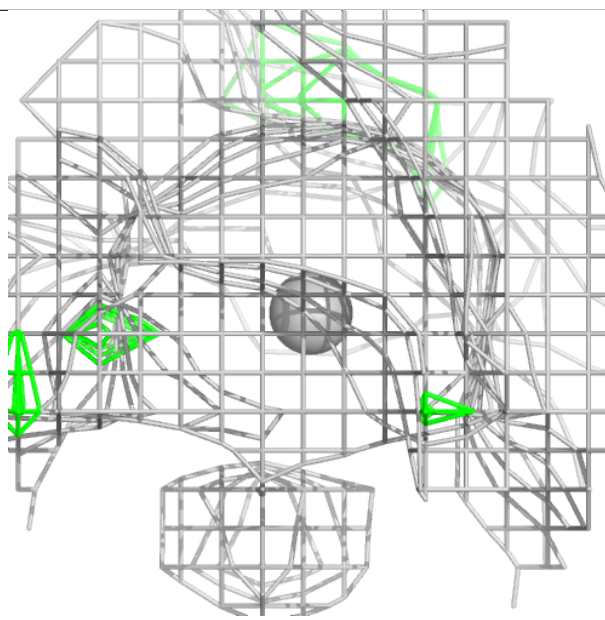
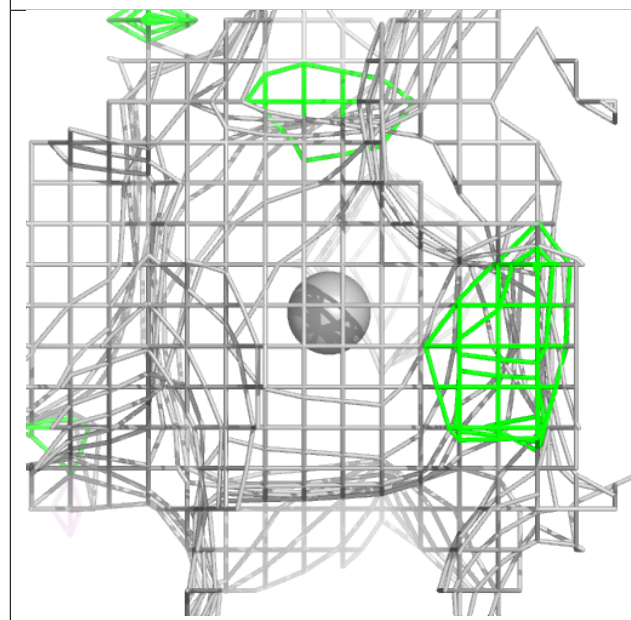
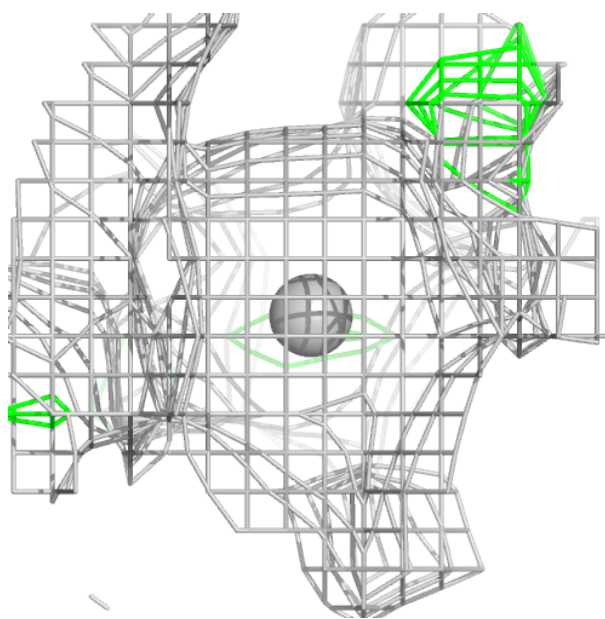

**Electron density around AG C 108:**

$2mF_o-DF_c$  (at 0.7 rmsd) in gray  
 $mF_o-DF_c$  (at 3 rmsd) in purple (negative)  
and green (positive)

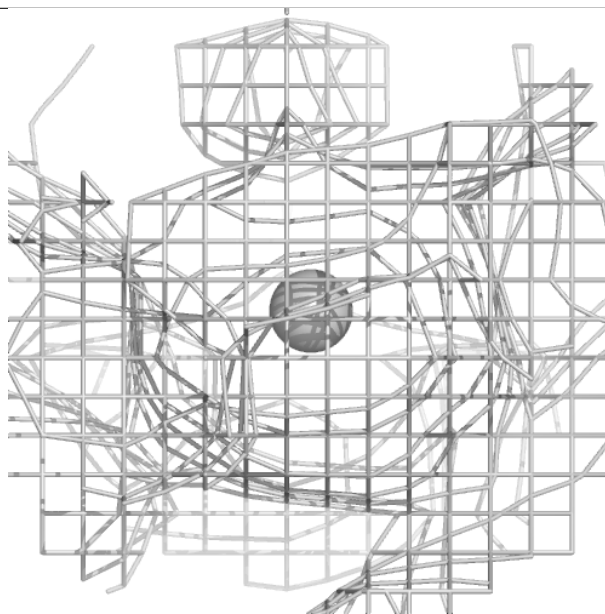
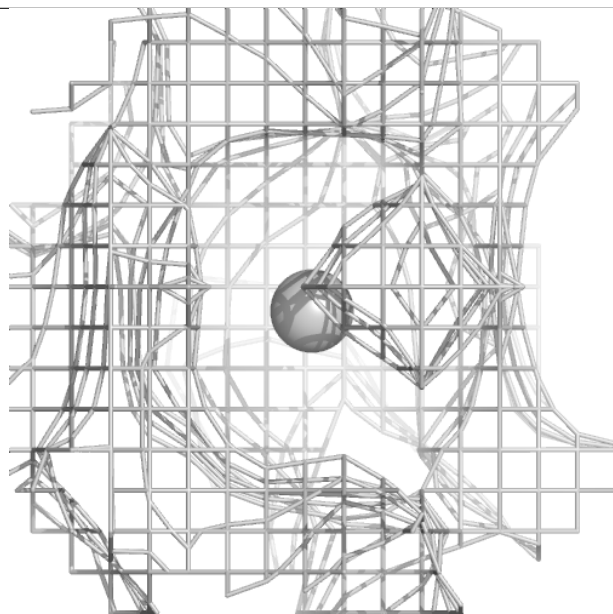
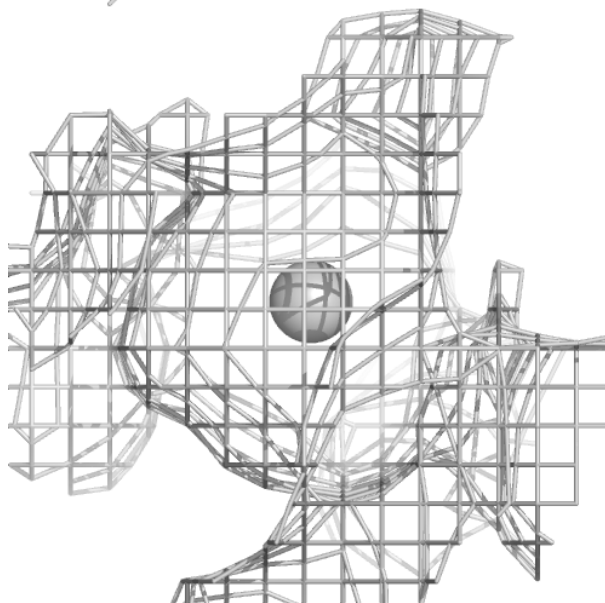

**Electron density around AG C 109:**

$2mF_o-DF_c$  (at 0.7 rmsd) in gray  
 $mF_o-DF_c$  (at 3 rmsd) in purple (negative)  
and green (positive)

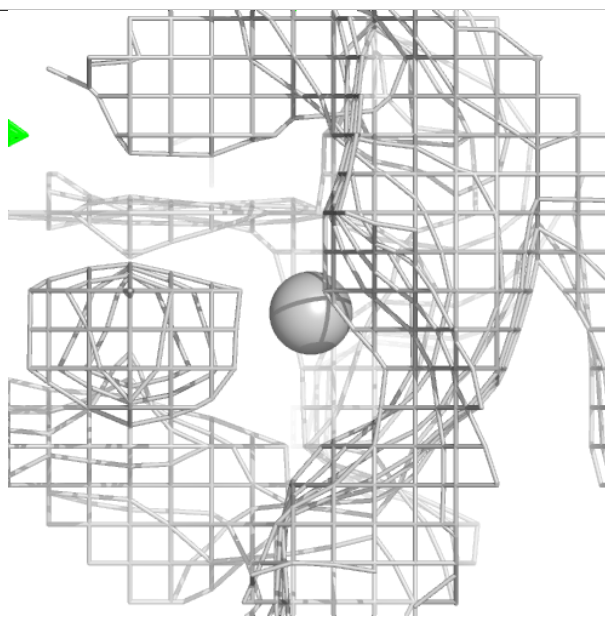
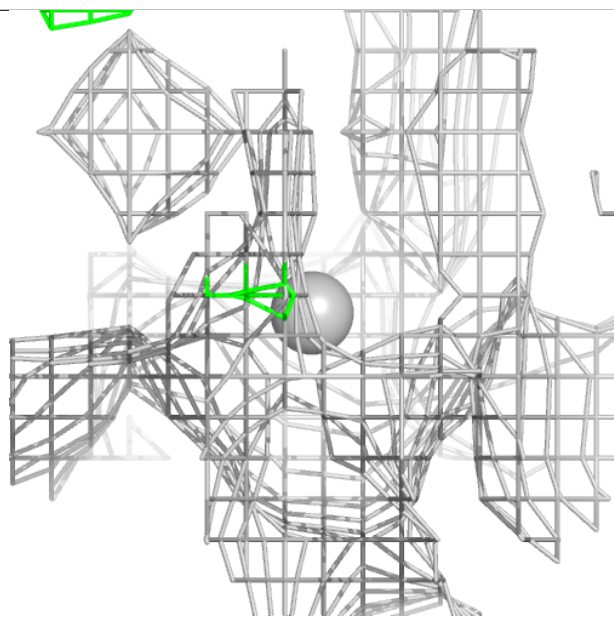
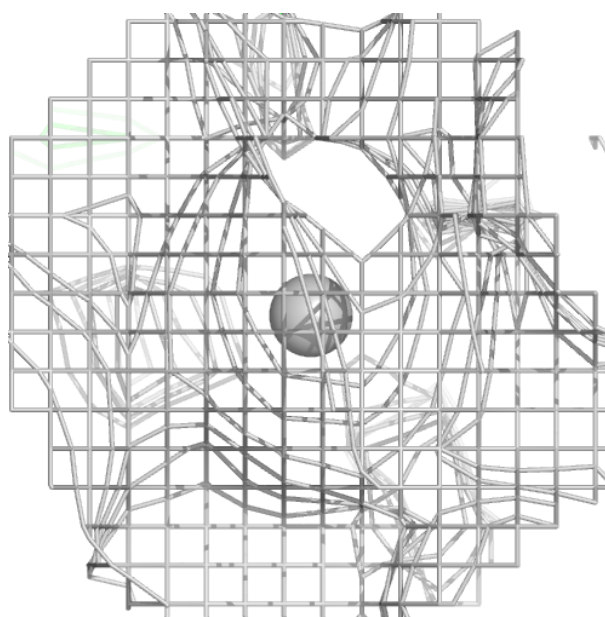

**Electron density around AG C 110:**

$2mF_o-DF_c$  (at 0.7 rmsd) in gray  
 $mF_o-DF_c$  (at 3 rmsd) in purple (negative)  
and green (positive)

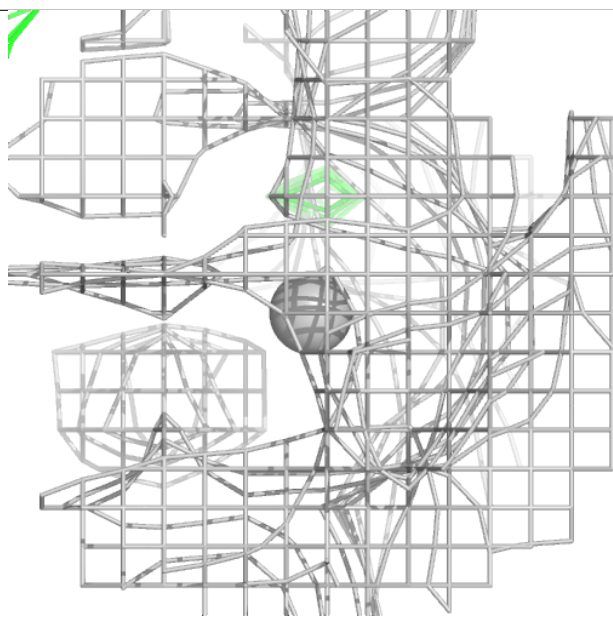
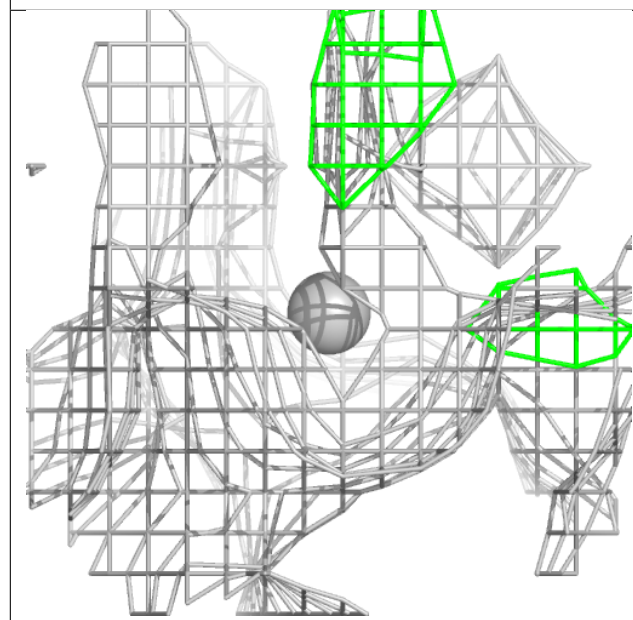
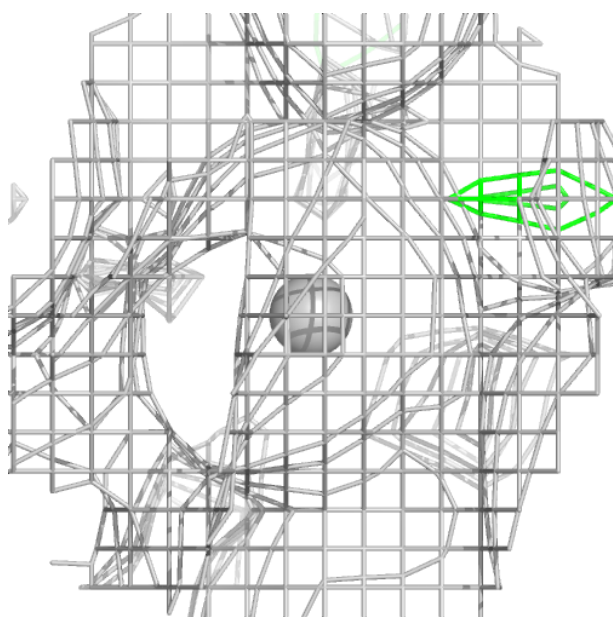

**Electron density around AG C 111:**

$2mF_o-DF_c$  (at 0.7 rmsd) in gray  
 $mF_o-DF_c$  (at 3 rmsd) in purple (negative)  
and green (positive)

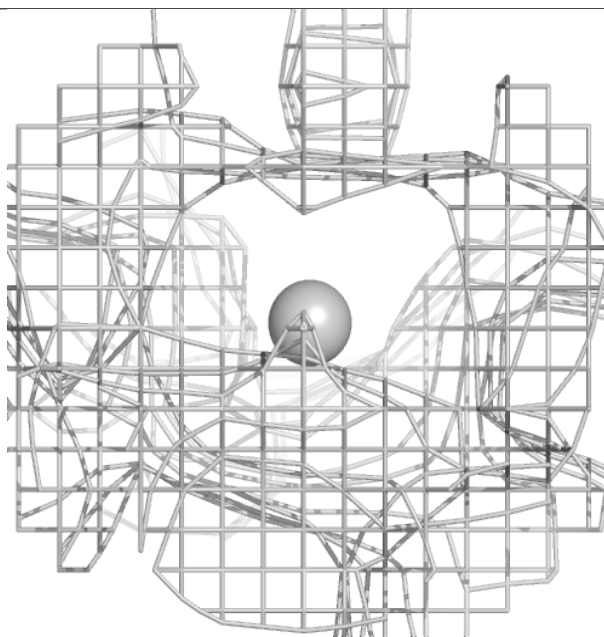
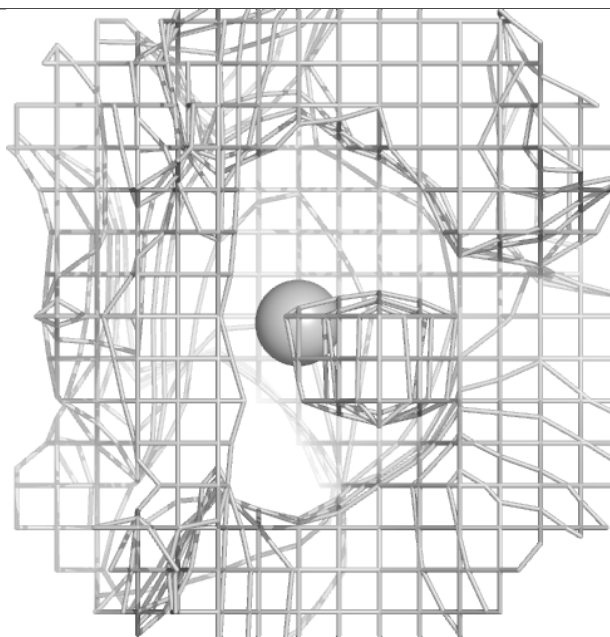
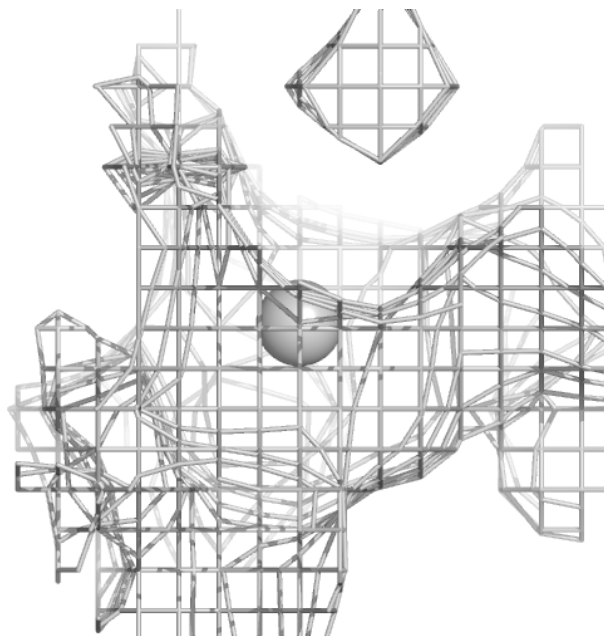

**Electron density around AG C 112:**

$2mF_o-DF_c$  (at 0.7 rmsd) in gray  
 $mF_o-DF_c$  (at 3 rmsd) in purple (negative)  
and green (positive)

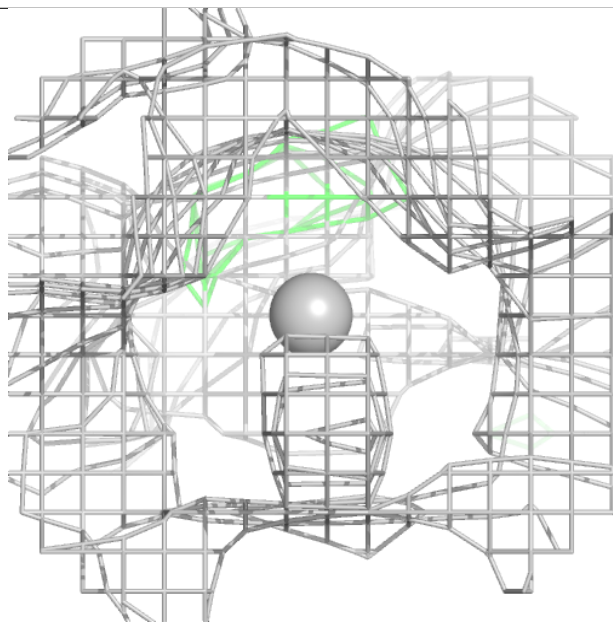
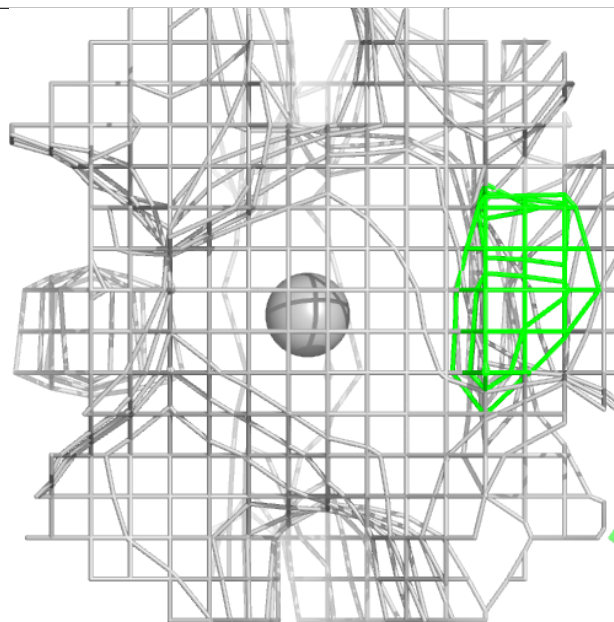
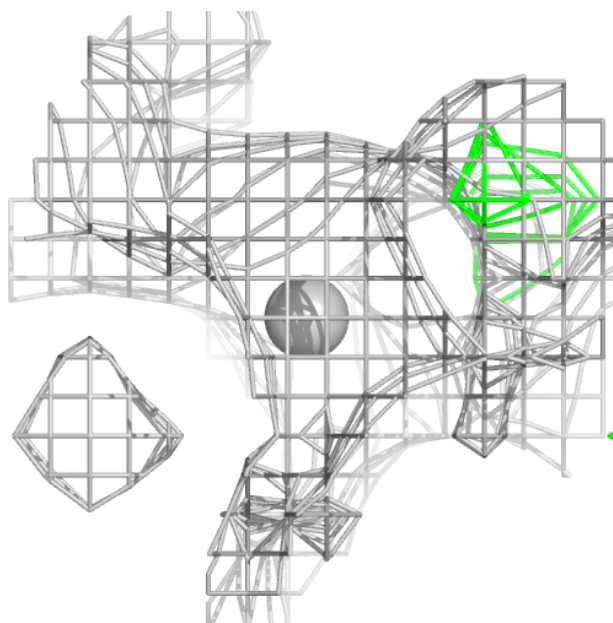

**Electron density around AG C 113:**

$2mF_o-DF_c$  (at 0.7 rmsd) in gray  
 $mF_o-DF_c$  (at 3 rmsd) in purple (negative)  
and green (positive)

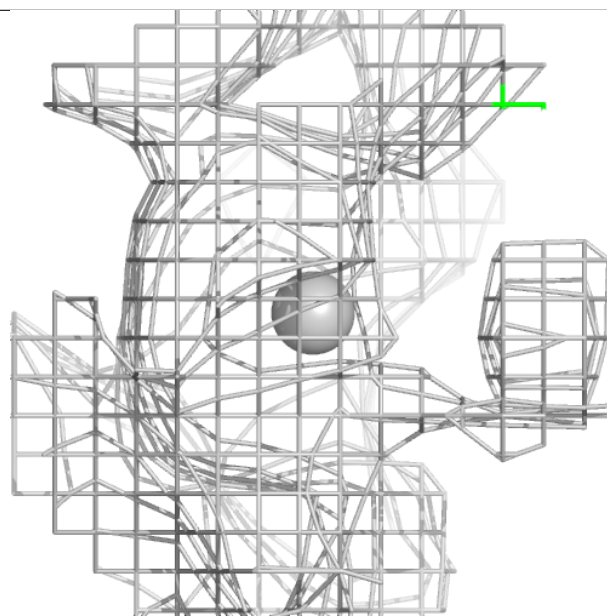
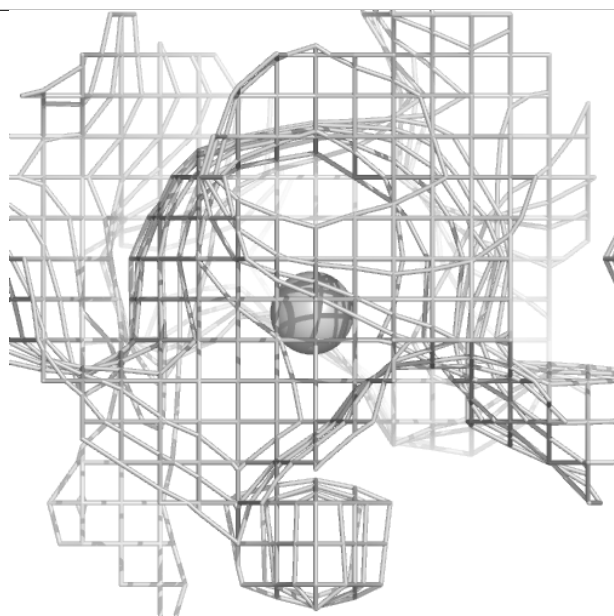
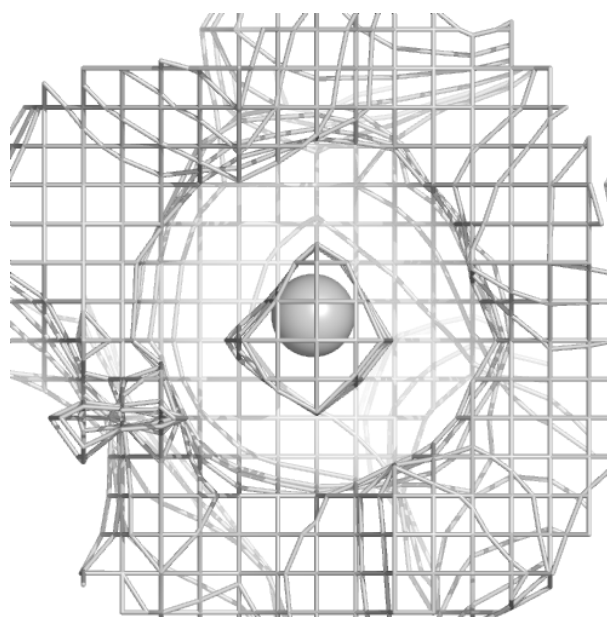

**Electron density around AG C 114:**

$2mF_o-DF_c$  (at 0.7 rmsd) in gray  
 $mF_o-DF_c$  (at 3 rmsd) in purple (negative)  
and green (positive)

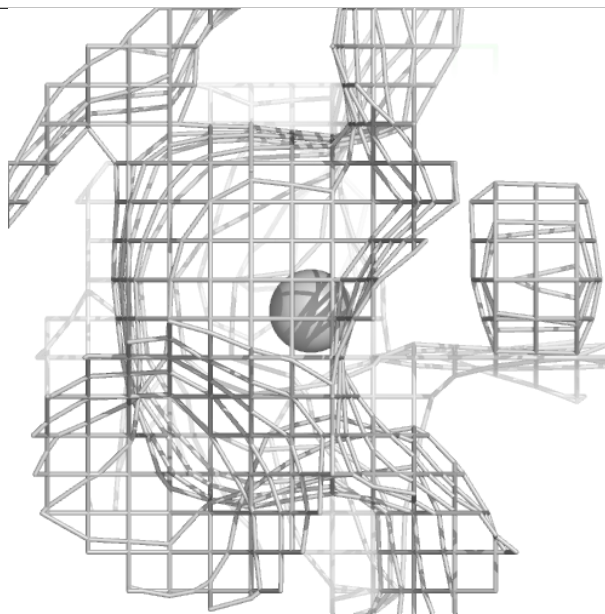
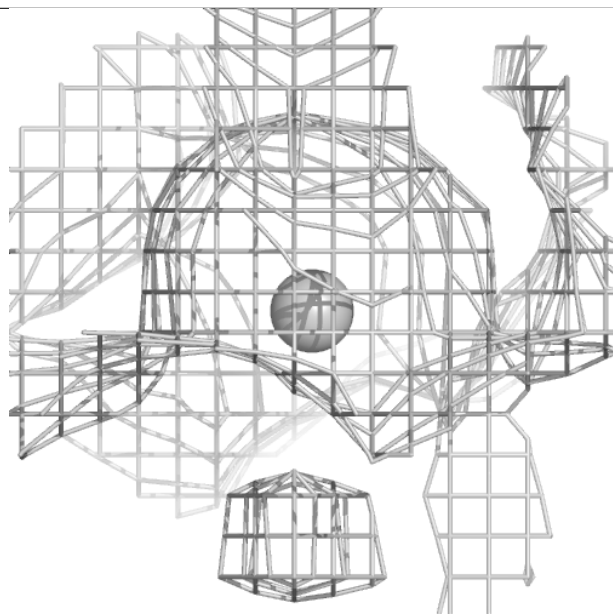
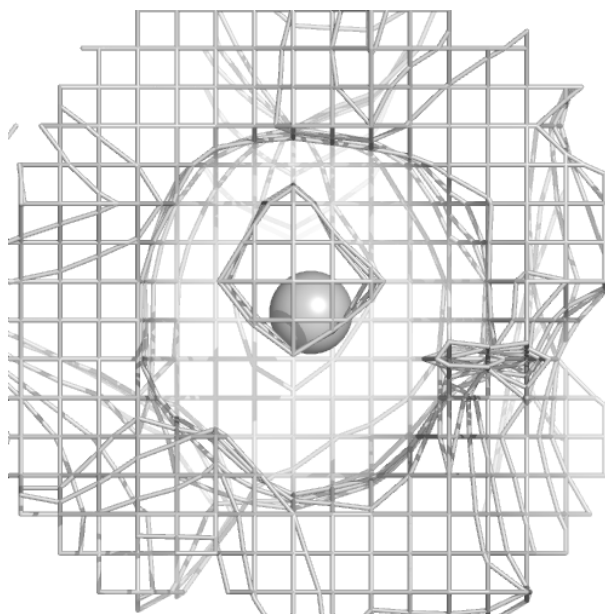

**Electron density around AG C 115:**

$2mF_o-DF_c$  (at 0.7 rmsd) in gray  
 $mF_o-DF_c$  (at 3 rmsd) in purple (negative)  
and green (positive)

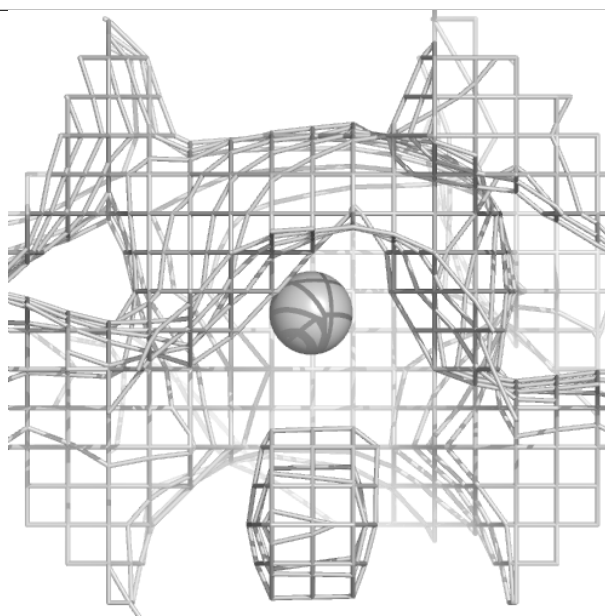
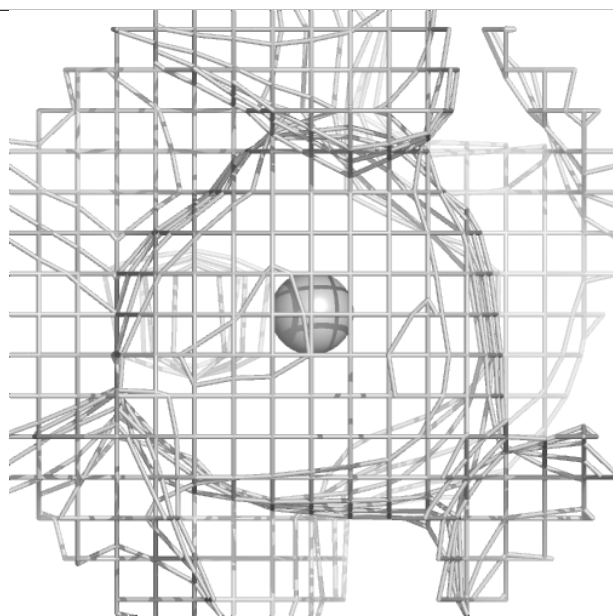
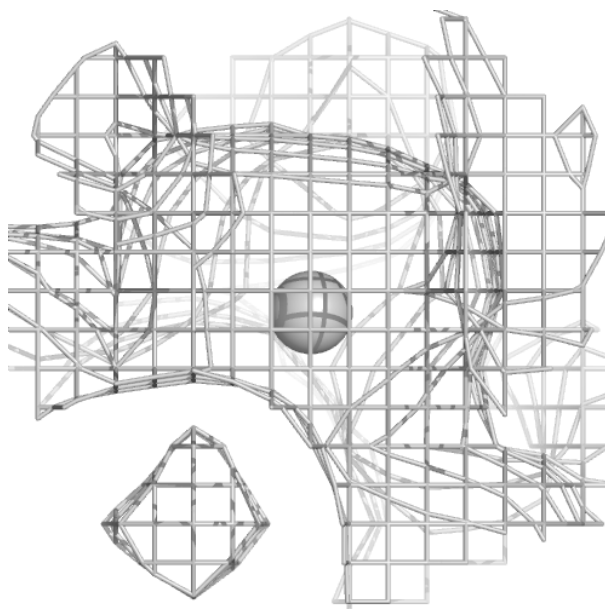

**Electron density around AG C 116:**

$2mF_o-DF_c$  (at 0.7 rmsd) in gray  
 $mF_o-DF_c$  (at 3 rmsd) in purple (negative)  
and green (positive)

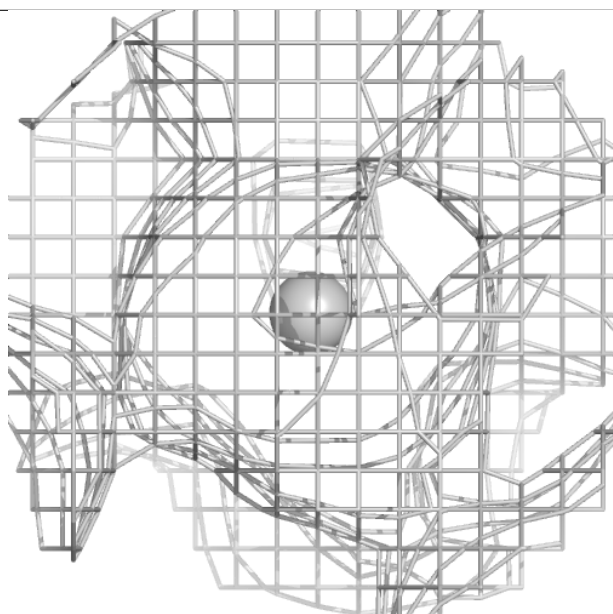
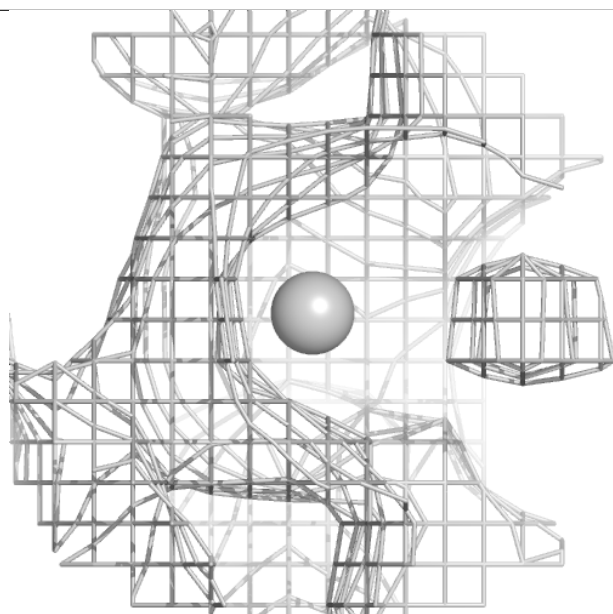
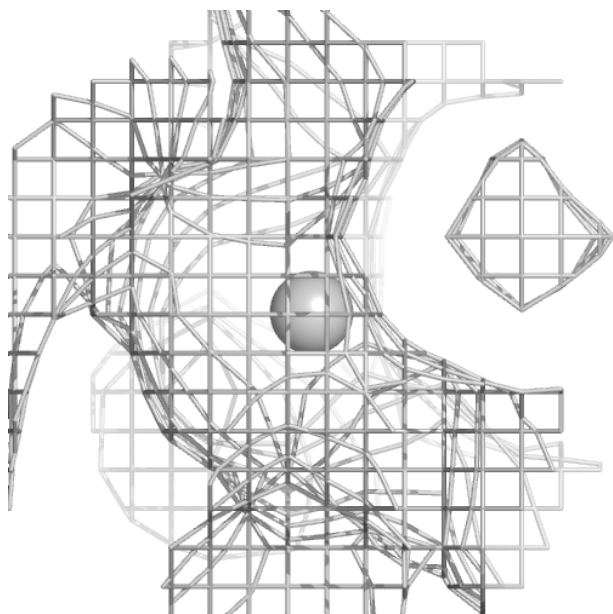

**Electron density around AG A 101:**

$2mF_o-DF_c$  (at 0.7 rmsd) in gray  
 $mF_o-DF_c$  (at 3 rmsd) in purple (negative)  
and green (positive)

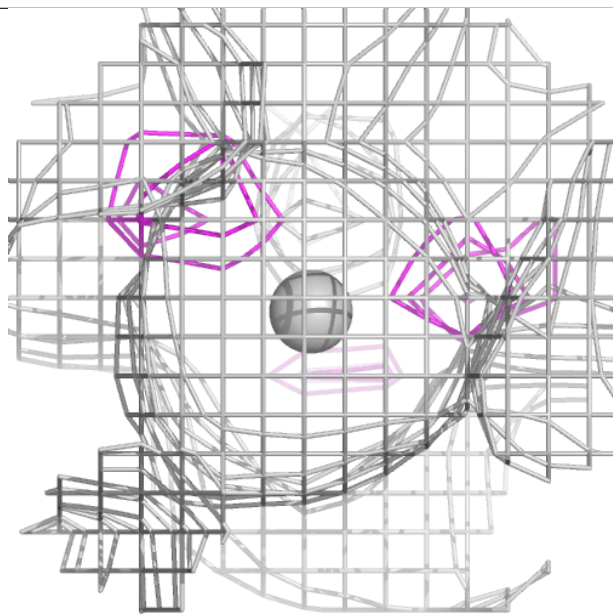
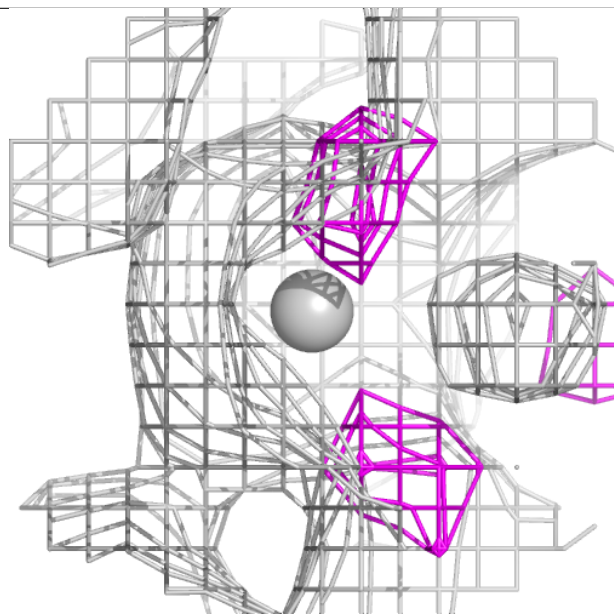
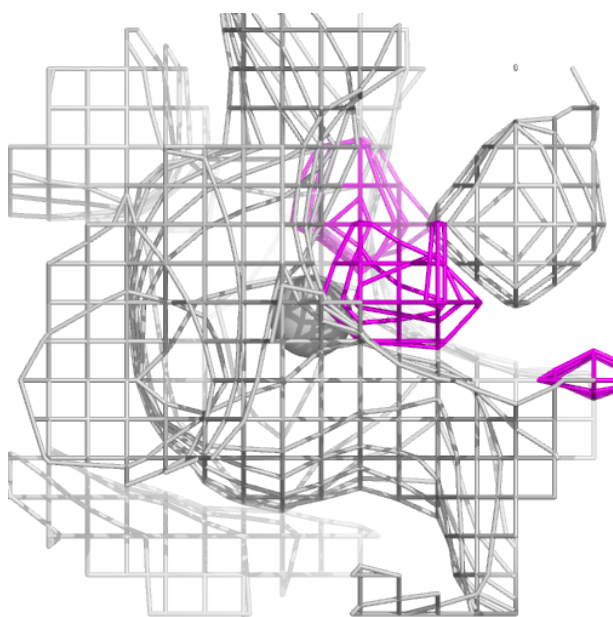

**Electron density around CL A 118:**

$2mF_o-DF_c$  (at 0.7 rmsd) in gray  
 $mF_o-DF_c$  (at 3 rmsd) in purple (negative)  
and green (positive)

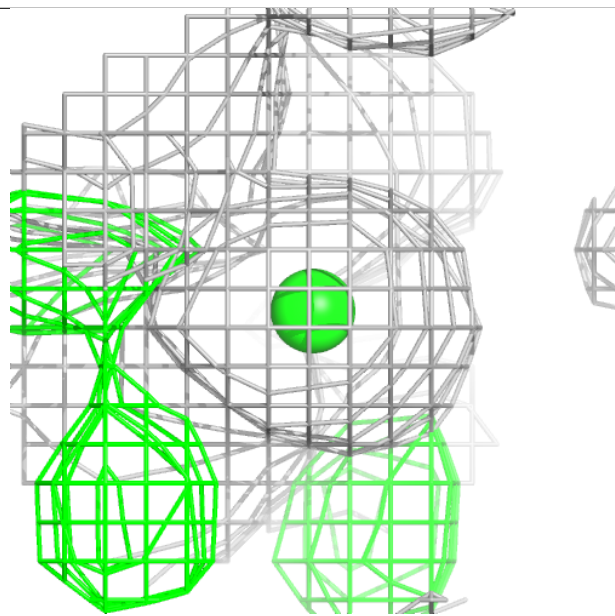
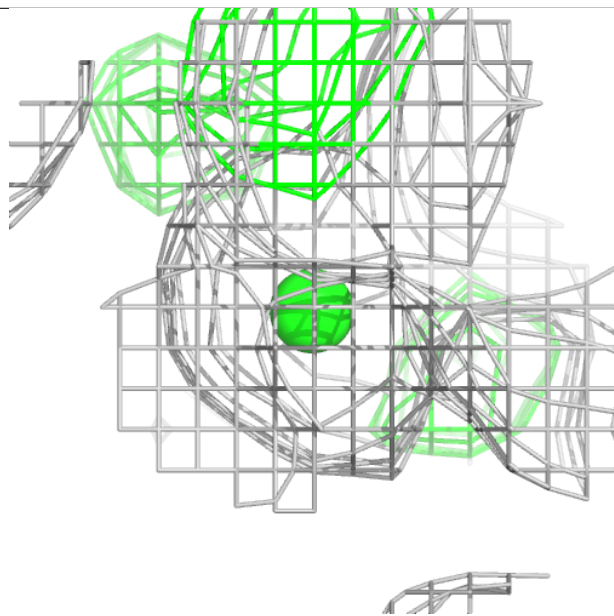
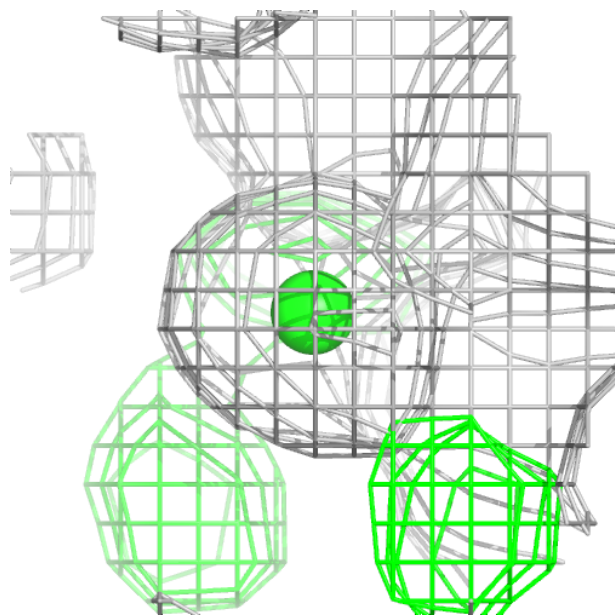

**Electron density around AG A 102:**

$2mF_o-DF_c$  (at 0.7 rmsd) in gray  
 $mF_o-DF_c$  (at 3 rmsd) in purple (negative)  
and green (positive)

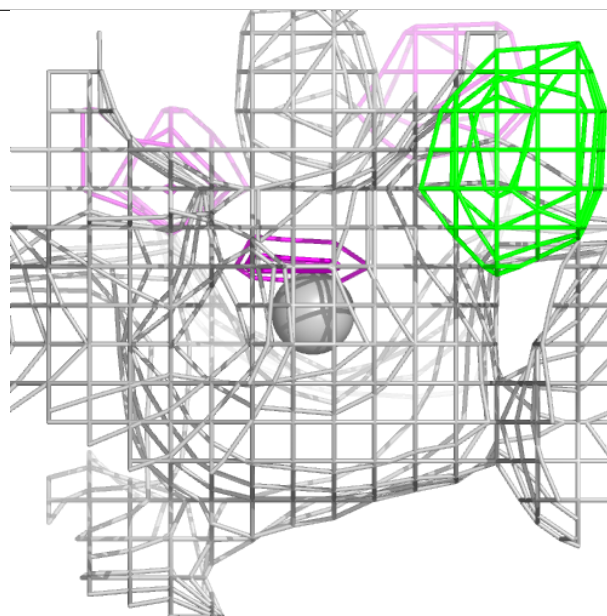
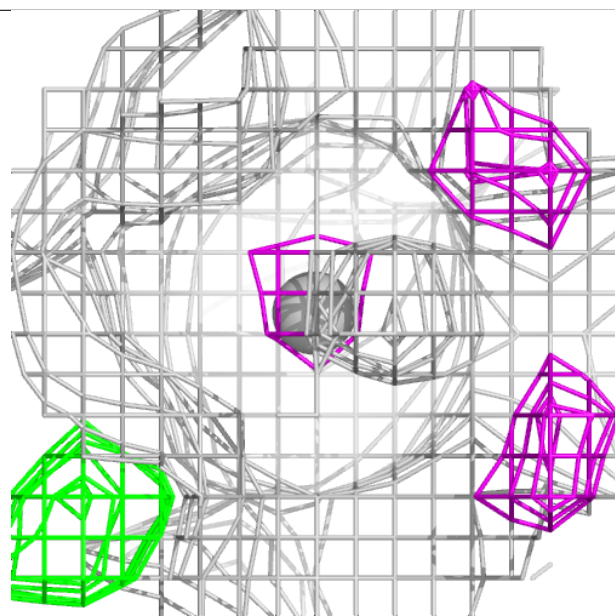
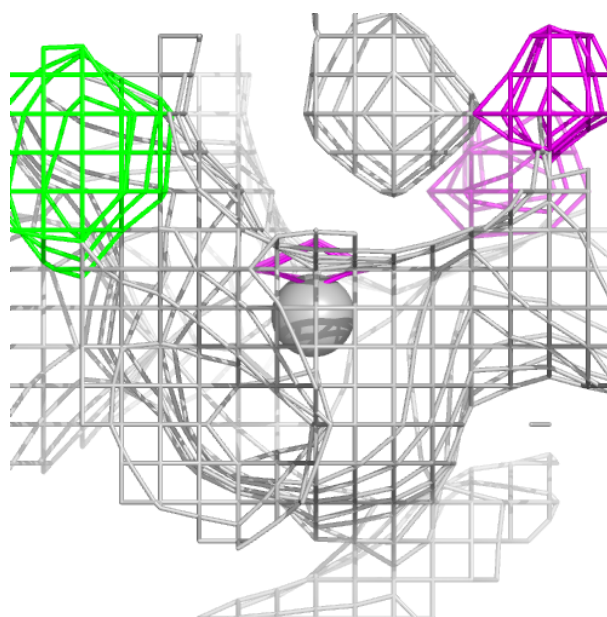

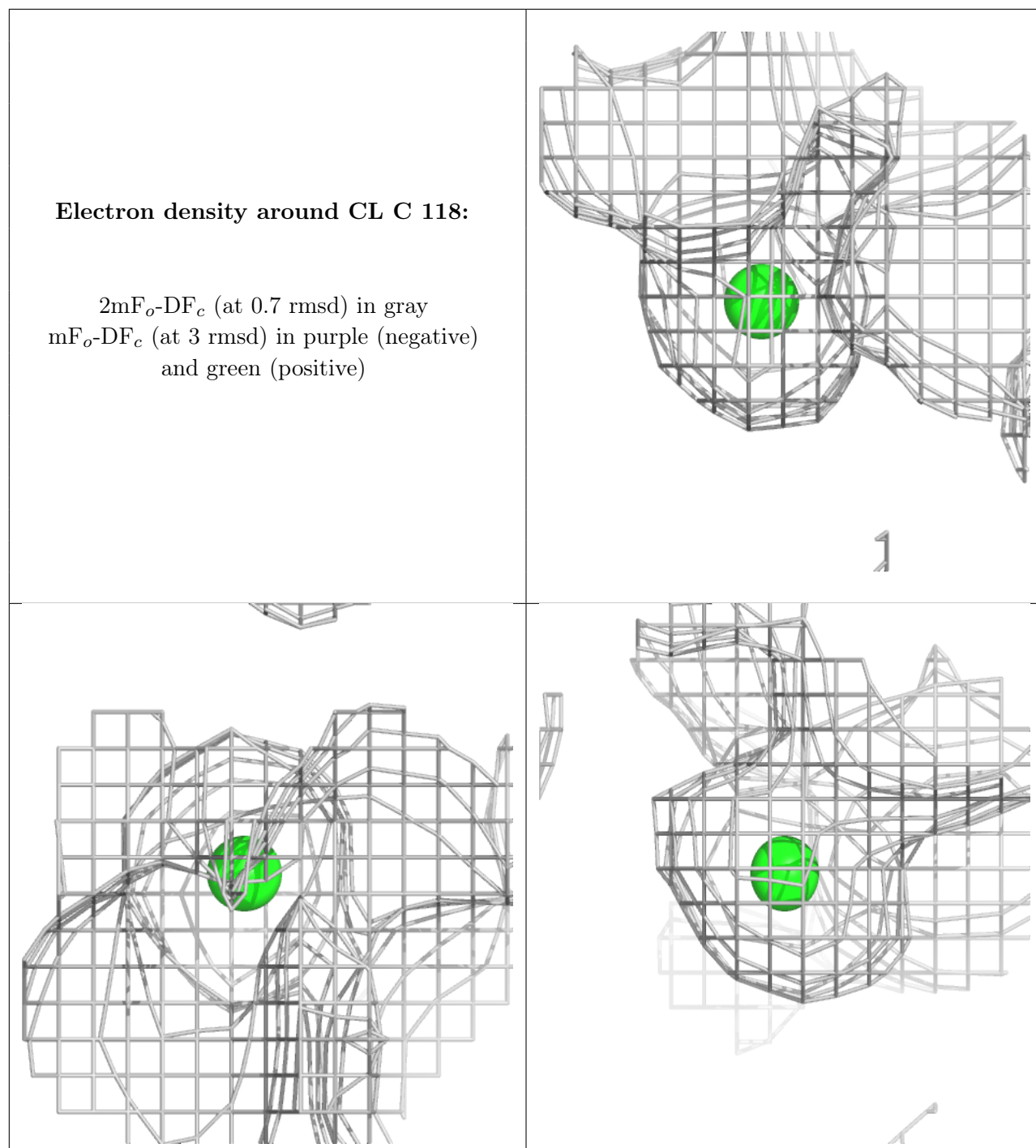

## 6.5 Other polymers [i](#)

There are no such residues in this entry.