



## wwPDB EM Validation Summary Report ⓘ

Mar 31, 2026 – 08:07 PM JST

PDB ID : 9WBG / pdb\_00009wbg  
EMDB ID : EMD-65839  
Title : Structure of human 26S proteasome complexed with midnolin, 19S proteasome with Ubl and Catch domain resolved  
Authors : Zhu, C.; Qin, L.; Liang, L.  
Deposited on : 2025-08-14  
Resolution : 4.23 Å(reported)

This is a wwPDB EM Validation Summary Report for a publicly released PDB entry.

We welcome your comments at [validation@mail.wwpdb.org](mailto:validation@mail.wwpdb.org)

A user guide is available at

<https://www.wwpdb.org/validation/2017/EMValidationReportHelp>

with specific help available everywhere you see the ⓘ symbol.

The types of validation reports are described at

<http://www.wwpdb.org/validation/2017/FAQs#types>.

---

The following versions of software and data (see [references ⓘ](#)) were used in the production of this report:

EMDB validation analysis : 0.0.1.dev132  
Mogul : 1.8.5 (274361), CSD as541be (2020)  
MolProbity : 4-5-2 with Phenix2.0  
buster-report : 1.1.7 (2018)  
Percentile statistics : 20231227.v01 (using entries in the PDB archive December 27th 2023)  
EM percentile statistics : 202505.v01 (Using data in the EMDB archive up until May 2025)  
MapQ : 1.9.13  
Ideal geometry (proteins) : Engh & Huber (2001)  
Ideal geometry (DNA, RNA) : Parkinson et al. (1996)  
Validation Pipeline (wwPDB-VP) : 2.48.1

# 1 Overall quality at a glance i

The following experimental techniques were used to determine the structure:  
*ELECTRON MICROSCOPY*

The reported resolution of this entry is 4.23 Å.

Percentile scores (ranging between 0-100) for global validation metrics of the entry are shown in the following graphic. The table shows the number of entries on which the scores are based.

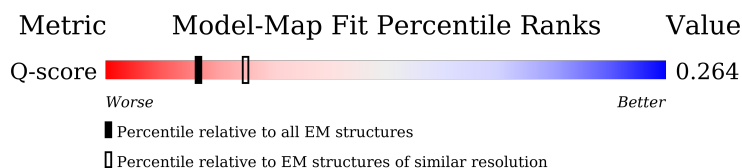
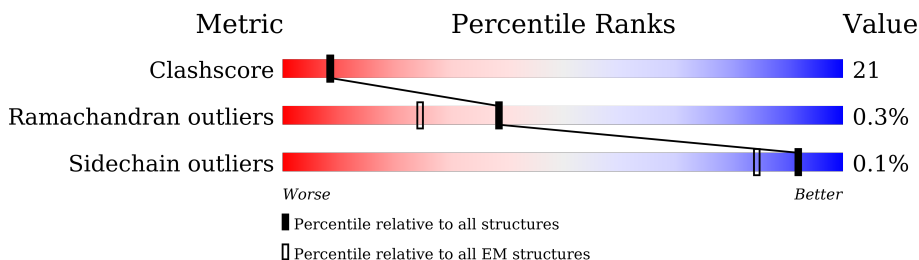









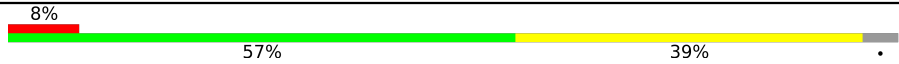

Metric	Whole archive (#Entries)	EM structures (#Entries)	Similar EM resolution (#Entries, resolution range(Å))
Clashscore	210492	15764	-
Ramachandran outliers	207382	16835	-
Sidechain outliers	206894	16415	-
Q-score	-	25397	4685 ( 3.74 - 4.73 )

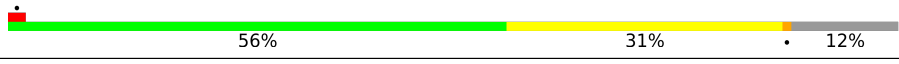
The table below summarises the geometric issues observed across the polymeric chains and their fit to the map. The red, orange, yellow and green segments of the bar indicate the fraction of residues that contain outliers for  $\geq 3$ , 2, 1 and 0 types of geometric quality criteria respectively. A grey segment represents the fraction of residues that are not modelled. The numeric value for each fraction is indicated below the corresponding segment, with a dot representing fractions  $\leq 5\%$ . The upper red bar (where present) indicates the fraction of residues that have poor fit to the EM map (all-atom inclusion  $< 40\%$ ). The numeric value is given above the bar.

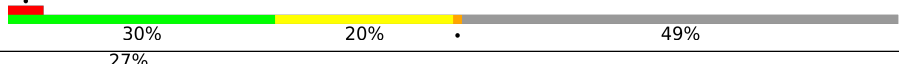
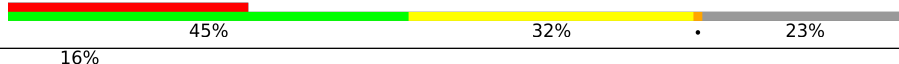
Mol	Chain	Length	Quality of chain
1	f	856	<p>5% (upper red bar), 12% (red), 10% (orange), 77% (grey)</p>
2	C	406	<p>25% (red), 50% (orange), 40% (yellow), 10% (grey)</p>
3	D	418	<p>12% (red), 52% (orange), 39% (yellow), 9% (grey)</p>
4	V	534	<p>22% (red), 45% (orange), 38% (yellow), 17% (grey)</p>

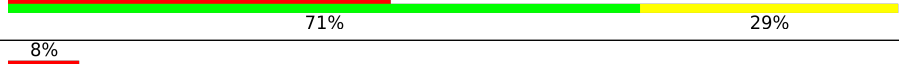
*Continued on next page...*

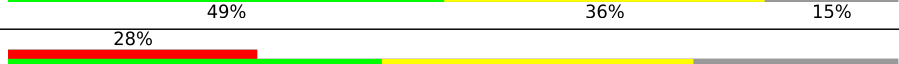
Continued from previous page...

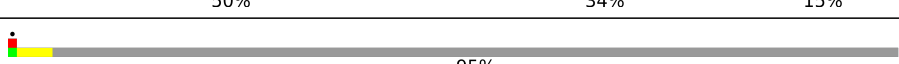
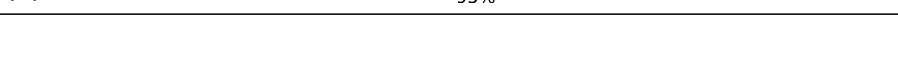
Mol	Chain	Length	Quality of chain
5	W	456	
6	X	422	
7	Y	389	
8	Z	324	
9	a	376	
10	b	377	
11	d	350	
12	e	70	
13	v	7	
14	U	953	
15	c	590	
16	A	433	
17	B	440	
18	E	389	
19	F	439	
20	w	337	

The following table lists non-polymeric compounds, carbohydrate monomers and non-standard residues in protein, DNA, RNA chains that are outliers for geometric or electron-density-fit criteria:

Mol	Type	Chain	Res	Chirality	Geometry	Clashes	Electron density
22	ATP	D	501	-	-	X	-

## 2 Entry composition

There are 24 unique types of molecules in this entry. The entry contains 50206 atoms, of which 0 are hydrogens and 0 are deuteriums.

In the tables below, the AltConf column contains the number of residues with at least one atom in alternate conformation and the Trace column contains the number of residues modelled with at most 2 atoms.

- Molecule 1 is a protein called Maltose/maltodextrin-binding periplasmic protein, Midnolin.

Mol	Chain	Residues	Atoms					AltConf	Trace
			Total	C	N	O	S		
1	f	196	1488	925	274	283	6	0	0

There are 22 discrepancies between the modelled and reference sequences:

Chain	Residue	Modelled	Actual	Comment	Reference
f	-387	MET	-	initiating methionine	UNP P0AEX9
f	-386	GLY	-	expression tag	UNP P0AEX9
f	-385	HIS	-	expression tag	UNP P0AEX9
f	-384	HIS	-	expression tag	UNP P0AEX9
f	-383	HIS	-	expression tag	UNP P0AEX9
f	-382	HIS	-	expression tag	UNP P0AEX9
f	-381	HIS	-	expression tag	UNP P0AEX9
f	-380	HIS	-	expression tag	UNP P0AEX9
f	-13	ASP	-	linker	UNP P0AEX9
f	-12	TYR	-	linker	UNP P0AEX9
f	-11	ASP	-	linker	UNP P0AEX9
f	-10	ILE	-	linker	UNP P0AEX9
f	-9	PRO	-	linker	UNP P0AEX9
f	-8	THR	-	linker	UNP P0AEX9
f	-7	THR	-	linker	UNP P0AEX9
f	-6	GLU	-	linker	UNP P0AEX9
f	-5	ASN	-	linker	UNP P0AEX9
f	-4	LEU	-	linker	UNP P0AEX9
f	-3	TYR	-	linker	UNP P0AEX9
f	-2	PHE	-	linker	UNP P0AEX9
f	-1	GLN	-	linker	UNP P0AEX9
f	0	GLY	-	linker	UNP P0AEX9

- Molecule 2 is a protein called 26S proteasome regulatory subunit 8.

Mol	Chain	Residues	Atoms					AltConf	Trace
			Total	C	N	O	S		
2	C	364	2870	1811	516	527	16	0	0

- Molecule 3 is a protein called 26S proteasome regulatory subunit 6B.

Mol	Chain	Residues	Atoms					AltConf	Trace
			Total	C	N	O	S		
3	D	380	3035	1921	523	578	13	0	0

- Molecule 4 is a protein called 26S proteasome non-ATPase regulatory subunit 3.

Mol	Chain	Residues	Atoms					AltConf	Trace
			Total	C	N	O	S		
4	V	442	3592	2290	639	650	13	0	0

- Molecule 5 is a protein called 26S proteasome non-ATPase regulatory subunit 12.

Mol	Chain	Residues	Atoms					AltConf	Trace
			Total	C	N	O	S		
5	W	440	3582	2269	609	681	23	0	0

- Molecule 6 is a protein called 26S proteasome non-ATPase regulatory subunit 11.

Mol	Chain	Residues	Atoms					AltConf	Trace
			Total	C	N	O	S		
6	X	384	3040	1935	513	580	12	0	0

- Molecule 7 is a protein called 26S proteasome non-ATPase regulatory subunit 6.

Mol	Chain	Residues	Atoms					AltConf	Trace
			Total	C	N	O	S		
7	Y	376	3103	1979	531	576	17	0	0

- Molecule 8 is a protein called 26S proteasome non-ATPase regulatory subunit 7.

Mol	Chain	Residues	Atoms					AltConf	Trace
			Total	C	N	O	S		
8	Z	286	2281	1457	392	427	5	0	0

- Molecule 9 is a protein called 26S proteasome non-ATPase regulatory subunit 13.

Mol	Chain	Residues	Atoms					AltConf	Trace
			Total	C	N	O	S		
9	a	373	2995	1911	510	559	15	0	0

- Molecule 10 is a protein called 26S proteasome non-ATPase regulatory subunit 4.

Mol	Chain	Residues	Atoms					AltConf	Trace
			Total	C	N	O	S		
10	b	191	1458	910	261	279	8	0	0

- Molecule 11 is a protein called 26S proteasome non-ATPase regulatory subunit 8.

Mol	Chain	Residues	Atoms					AltConf	Trace
			Total	C	N	O	S		
11	d	270	2193	1417	360	407	9	0	0

- Molecule 12 is a protein called 26S proteasome complex subunit SEM1.

Mol	Chain	Residues	Atoms				AltConf	Trace
			Total	C	N	O		
12	e	48	409	249	63	97	0	0

- Molecule 13 is a protein called Substrate.

Mol	Chain	Residues	Atoms				AltConf	Trace
			Total	C	N	O		
13	v	7	35	21	7	7	0	0

- Molecule 14 is a protein called 26S proteasome non-ATPase regulatory subunit 1.

Mol	Chain	Residues	Atoms					AltConf	Trace
			Total	C	N	O	S		
14	U	818	6371	4046	1085	1196	44	0	0

- Molecule 15 is a protein called Ubiquitin C-terminal hydrolase PSMD14, Uncharacterized protein.

Mol	Chain	Residues	Atoms					AltConf	Trace
			Total	C	N	O	S		
15	c	293	2304	1457	396	432	19	0	0

There are 44 discrepancies between the modelled and reference sequences:

Chain	Residue	Modelled	Actual	Comment	Reference
c	311	GLU	-	linker	UNP O00487
c	312	ASN	-	linker	UNP O00487
c	313	LEU	-	linker	UNP O00487
c	314	TYR	-	linker	UNP O00487
c	315	PHE	-	linker	UNP O00487
c	316	GLN	-	linker	UNP O00487
c	317	GLY	-	linker	UNP O00487
c	318	ALA	-	linker	UNP O00487
c	555	HIS	-	expression tag	UNP A0ACC5U4E7
c	556	HIS	-	expression tag	UNP A0ACC5U4E7
c	557	HIS	-	expression tag	UNP A0ACC5U4E7
c	558	HIS	-	expression tag	UNP A0ACC5U4E7
c	559	HIS	-	expression tag	UNP A0ACC5U4E7
c	560	HIS	-	expression tag	UNP A0ACC5U4E7
c	561	SER	-	expression tag	UNP A0ACC5U4E7
c	562	ALA	-	expression tag	UNP A0ACC5U4E7
c	563	TRP	-	expression tag	UNP A0ACC5U4E7
c	564	SER	-	expression tag	UNP A0ACC5U4E7
c	565	HIS	-	expression tag	UNP A0ACC5U4E7
c	566	PRO	-	expression tag	UNP A0ACC5U4E7
c	567	GLN	-	expression tag	UNP A0ACC5U4E7
c	568	PHE	-	expression tag	UNP A0ACC5U4E7
c	569	GLU	-	expression tag	UNP A0ACC5U4E7
c	570	LYS	-	expression tag	UNP A0ACC5U4E7
c	571	GLY	-	expression tag	UNP A0ACC5U4E7
c	572	GLY	-	expression tag	UNP A0ACC5U4E7
c	573	GLY	-	expression tag	UNP A0ACC5U4E7
c	574	SER	-	expression tag	UNP A0ACC5U4E7
c	575	GLY	-	expression tag	UNP A0ACC5U4E7
c	576	GLY	-	expression tag	UNP A0ACC5U4E7
c	577	GLY	-	expression tag	UNP A0ACC5U4E7
c	578	SER	-	expression tag	UNP A0ACC5U4E7
c	579	GLY	-	expression tag	UNP A0ACC5U4E7
c	580	GLY	-	expression tag	UNP A0ACC5U4E7
c	581	SER	-	expression tag	UNP A0ACC5U4E7
c	582	ALA	-	expression tag	UNP A0ACC5U4E7
c	583	TRP	-	expression tag	UNP A0ACC5U4E7
c	584	SER	-	expression tag	UNP A0ACC5U4E7
c	585	HIS	-	expression tag	UNP A0ACC5U4E7
c	586	PRO	-	expression tag	UNP A0ACC5U4E7
c	587	GLN	-	expression tag	UNP A0ACC5U4E7
c	588	PHE	-	expression tag	UNP A0ACC5U4E7
c	589	GLU	-	expression tag	UNP A0ACC5U4E7

*Continued on next page...*

*Continued from previous page...*

Chain	Residue	Modelled	Actual	Comment	Reference
c	590	LYS	-	expression tag	UNP A0ACC5U4E7

- Molecule 16 is a protein called 26S proteasome regulatory subunit 7.

Mol	Chain	Residues	Atoms					AltConf	Trace
			Total	C	N	O	S		
16	A	366	2863	1805	503	537	18	0	0

- Molecule 17 is a protein called 26S proteasome regulatory subunit 4.

Mol	Chain	Residues	Atoms					AltConf	Trace
			Total	C	N	O	S		
17	B	340	2647	1663	451	521	12	0	0

- Molecule 18 is a protein called 26S proteasome regulatory subunit 10B.

Mol	Chain	Residues	Atoms					AltConf	Trace
			Total	C	N	O	S		
18	E	347	2721	1713	484	508	16	0	0

- Molecule 19 is a protein called 26S proteasome regulatory subunit 6A.

Mol	Chain	Residues	Atoms					AltConf	Trace
			Total	C	N	O	S		
19	F	372	2902	1823	501	562	16	0	0

- Molecule 20 is a protein called Early growth response protein 1.

Mol	Chain	Residues	Atoms				AltConf	Trace
			Total	C	N	O		
20	w	17	135	89	23	23	0	0

- Molecule 21 is ADENOSINE-5'-DIPHOSPHATE (CCD ID: ADP) (formula: C<sub>10</sub>H<sub>15</sub>N<sub>5</sub>O<sub>10</sub>P<sub>2</sub>) (labeled as "Ligand of Interest" by depositor).

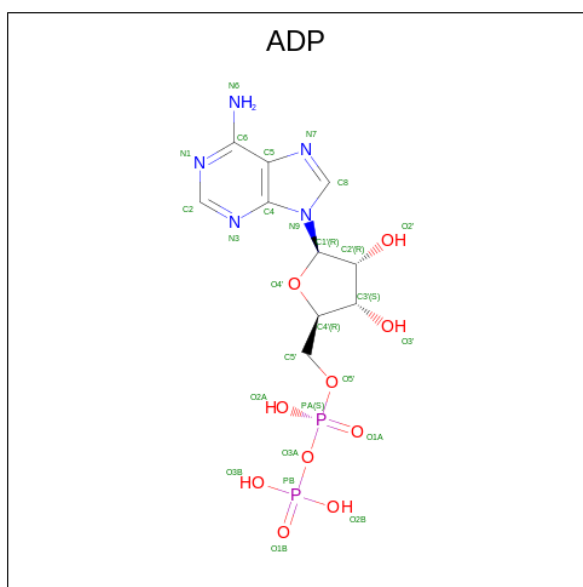

Mol	Chain	Residues	Atoms					AltConf
			Total	C	N	O	P	
21	C	1	Total	C	N	O	P	0
			27	10	5	10	2	
21	F	1	Total	C	N	O	P	0
			27	10	5	10	2	

- Molecule 22 is ADENOSINE-5'-TRIPHOSPHATE (CCD ID: ATP) (formula:  $C_{10}H_{16}N_5O_{13}P_3$ ) (labeled as "Ligand of Interest" by depositor).

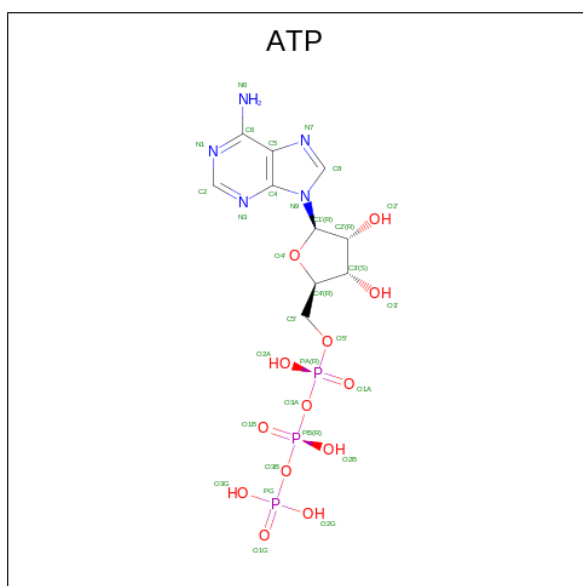

Mol	Chain	Residues	Atoms					AltConf
			Total	C	N	O	P	
22	D	1	Total	C	N	O	P	0
			31	10	5	13	3	

*Continued on next page...*

*Continued from previous page...*

Mol	Chain	Residues	Atoms				AltConf	
22	A	1	Total	C	N	O	P	0
			31	10	5	13	3	
22	B	1	Total	C	N	O	P	0
			31	10	5	13	3	
22	E	1	Total	C	N	O	P	0
			31	10	5	13	3	

- Molecule 23 is ZINC ION (CCD ID: ZN) (formula: Zn) (labeled as "Ligand of Interest" by depositor).

Mol	Chain	Residues	Atoms		AltConf
23	c	1	Total	Zn	0
			1	1	

- Molecule 24 is MAGNESIUM ION (CCD ID: MG) (formula: Mg) (labeled as "Ligand of Interest" by depositor).

Mol	Chain	Residues	Atoms		AltConf
24	B	1	Total	Mg	0
			1	1	
24	E	1	Total	Mg	0
			1	1	
24	F	1	Total	Mg	0
			1	1	

### 3 Residue-property plots

These plots are drawn for all protein, RNA, DNA and oligosaccharide chains in the entry. The first graphic for a chain summarises the proportions of the various outlier classes displayed in the second graphic. The second graphic shows the sequence view annotated by issues in geometry and atom inclusion in map density. Residues are color-coded according to the number of geometric quality criteria for which they contain at least one outlier: green = 0, yellow = 1, orange = 2 and red = 3 or more. A red diamond above a residue indicates a poor fit to the EM map for this residue (all-atom inclusion < 40%). Stretches of 2 or more consecutive residues without any outlier are shown as a green connector. Residues present in the sample, but not in the model, are shown in grey.

- Molecule 1: Maltose/maltodextrin-binding periplasmic protein, Midnolin

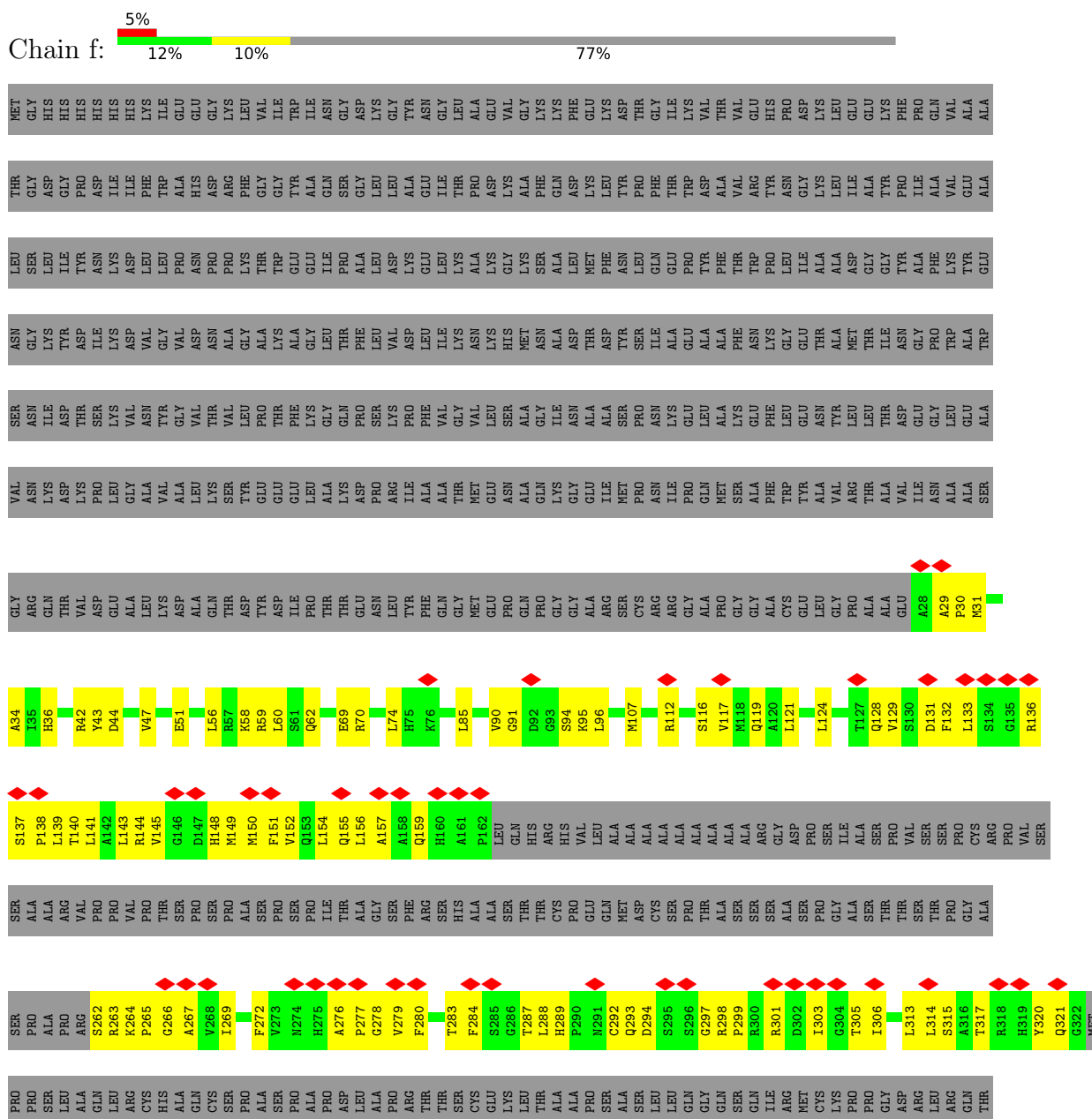





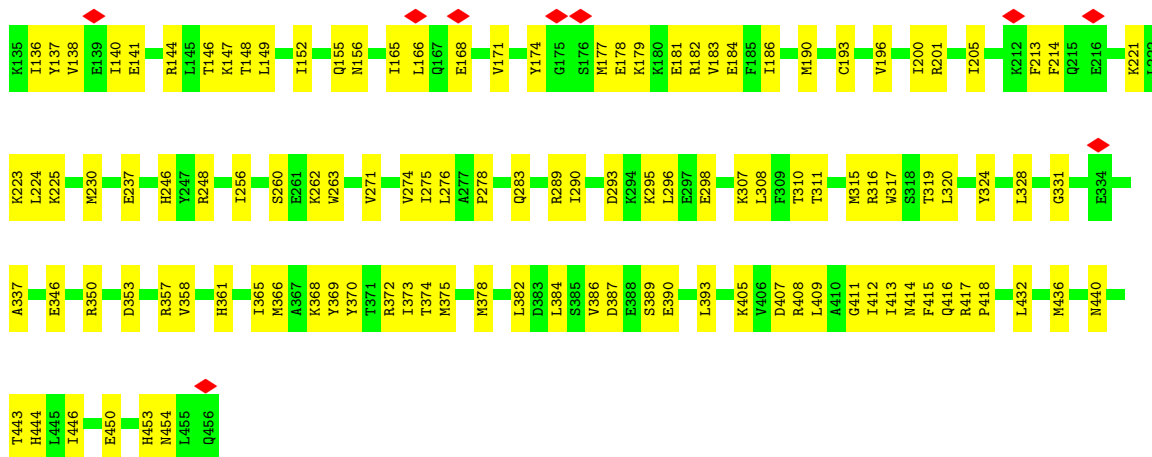

● Molecule 6: 26S proteasome non-ATPase regulatory subunit 11

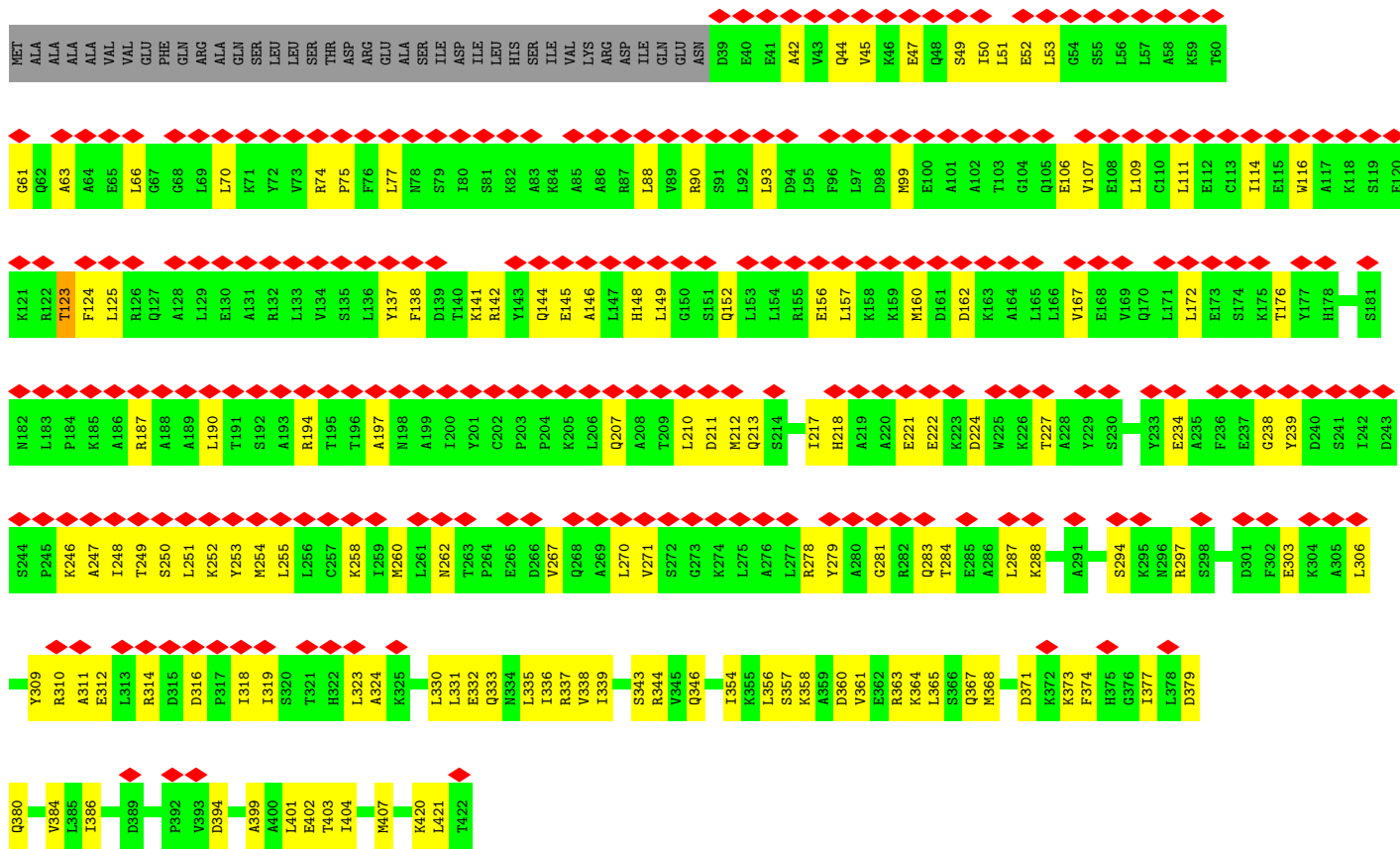

● Molecule 7: 26S proteasome non-ATPase regulatory subunit 6



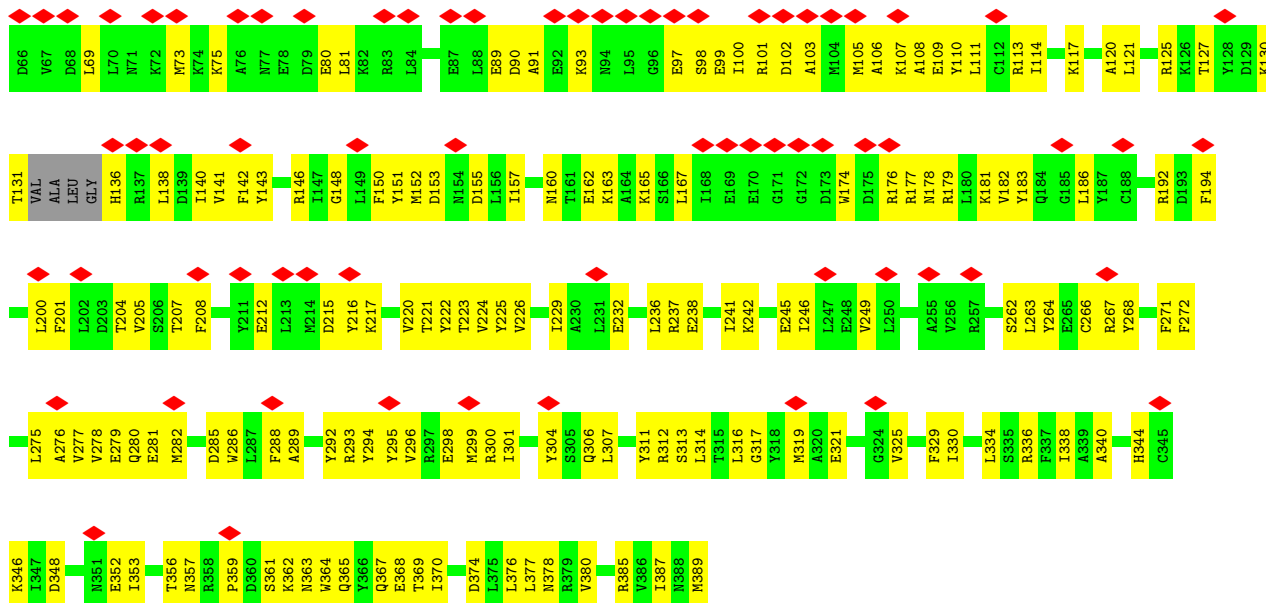

• Molecule 8: 26S proteasome non-ATPase regulatory subunit 7

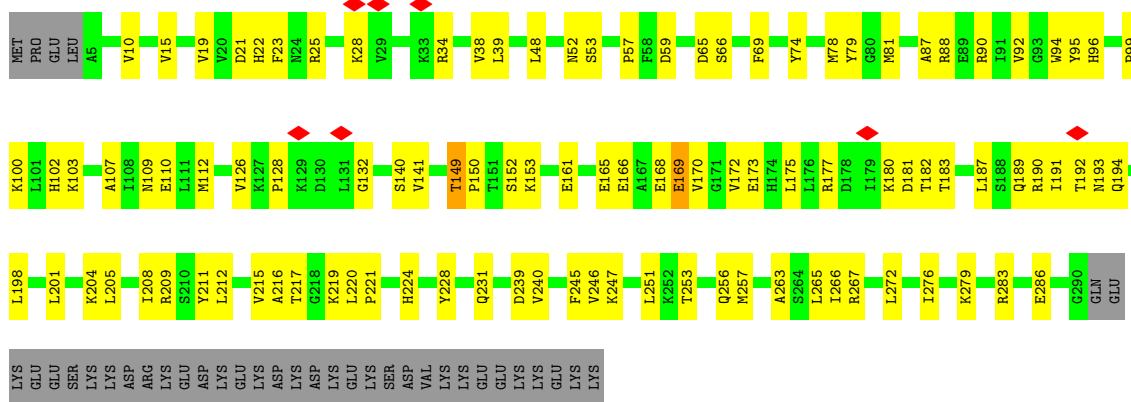

• Molecule 9: 26S proteasome non-ATPase regulatory subunit 13

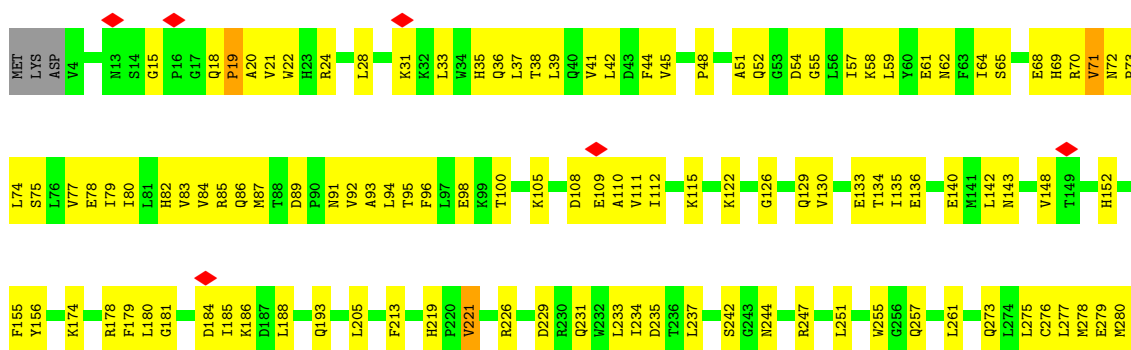

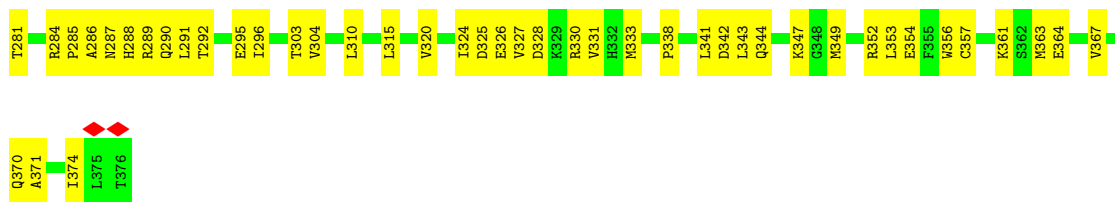

• Molecule 10: 26S proteasome non-ATPase regulatory subunit 4

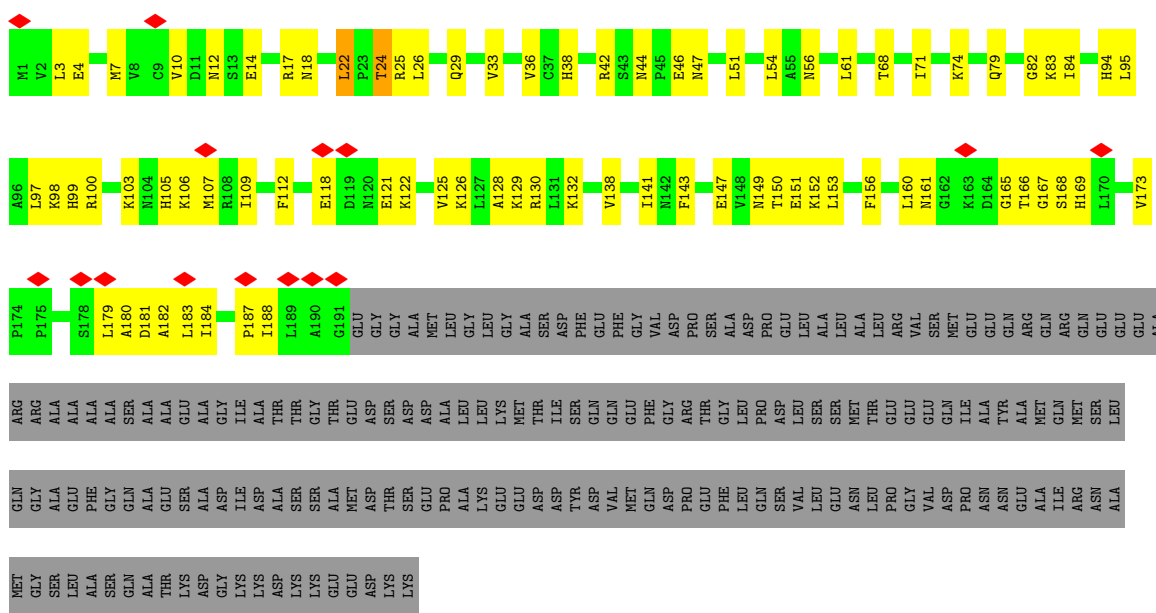
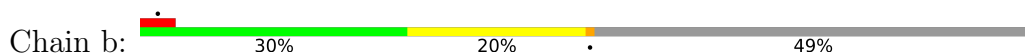

• Molecule 11: 26S proteasome non-ATPase regulatory subunit 8

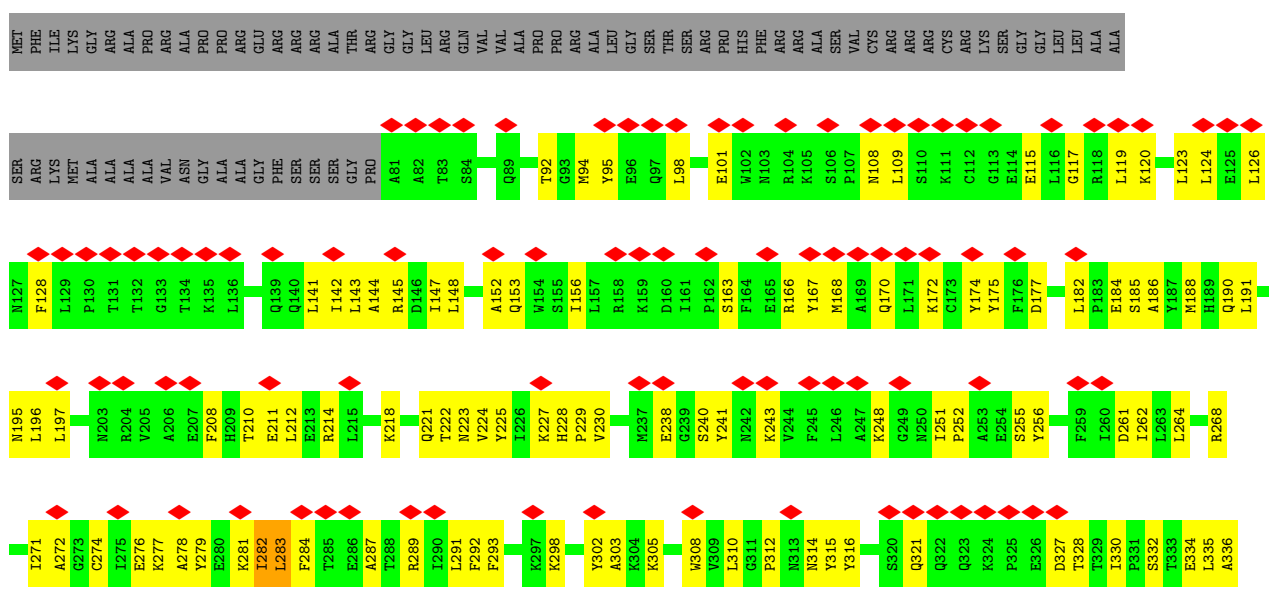
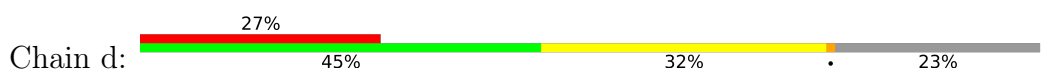



• Molecule 12: 26S proteasome complex subunit SEM1

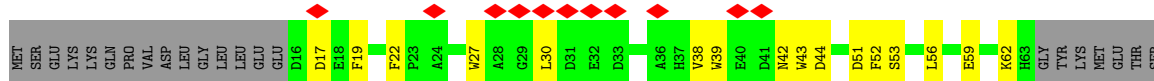

• Molecule 13: Substrate

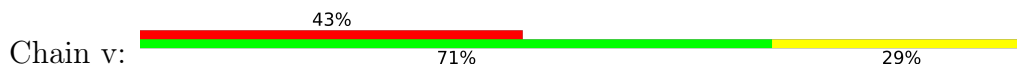

• Molecule 14: 26S proteasome non-ATPase regulatory subunit 1

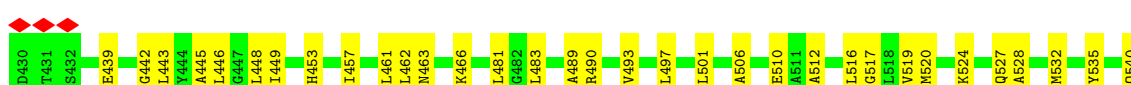
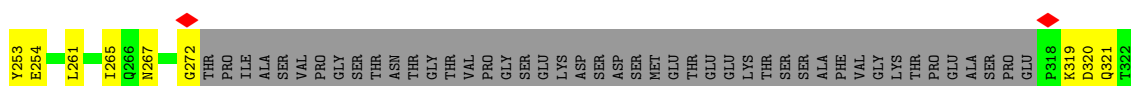
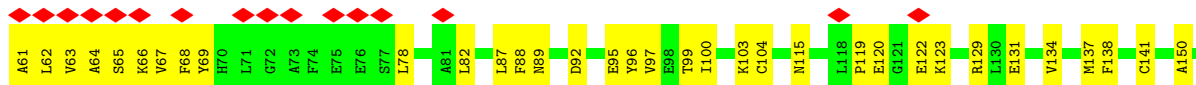



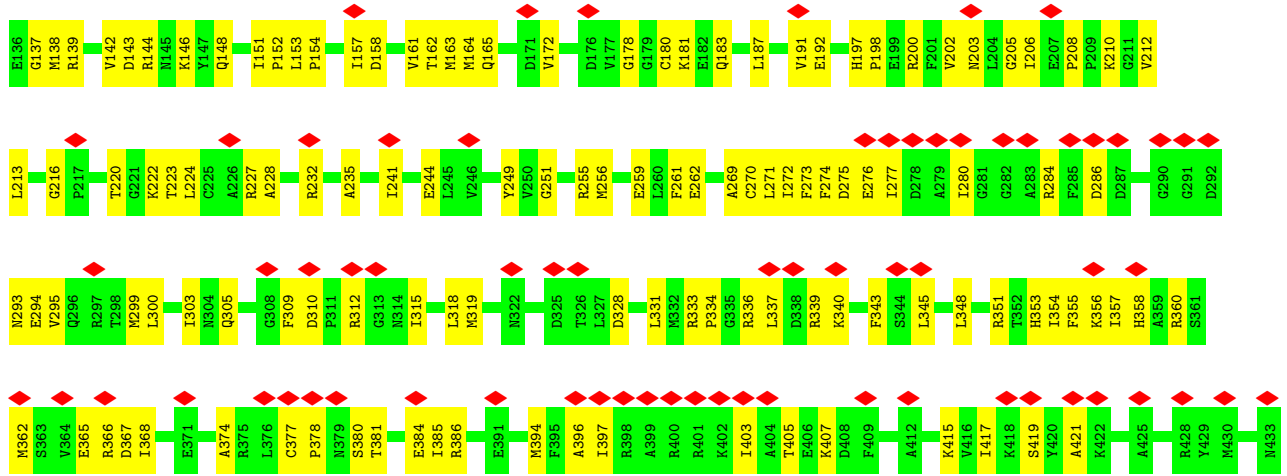

• Molecule 17: 26S proteasome regulatory subunit 4

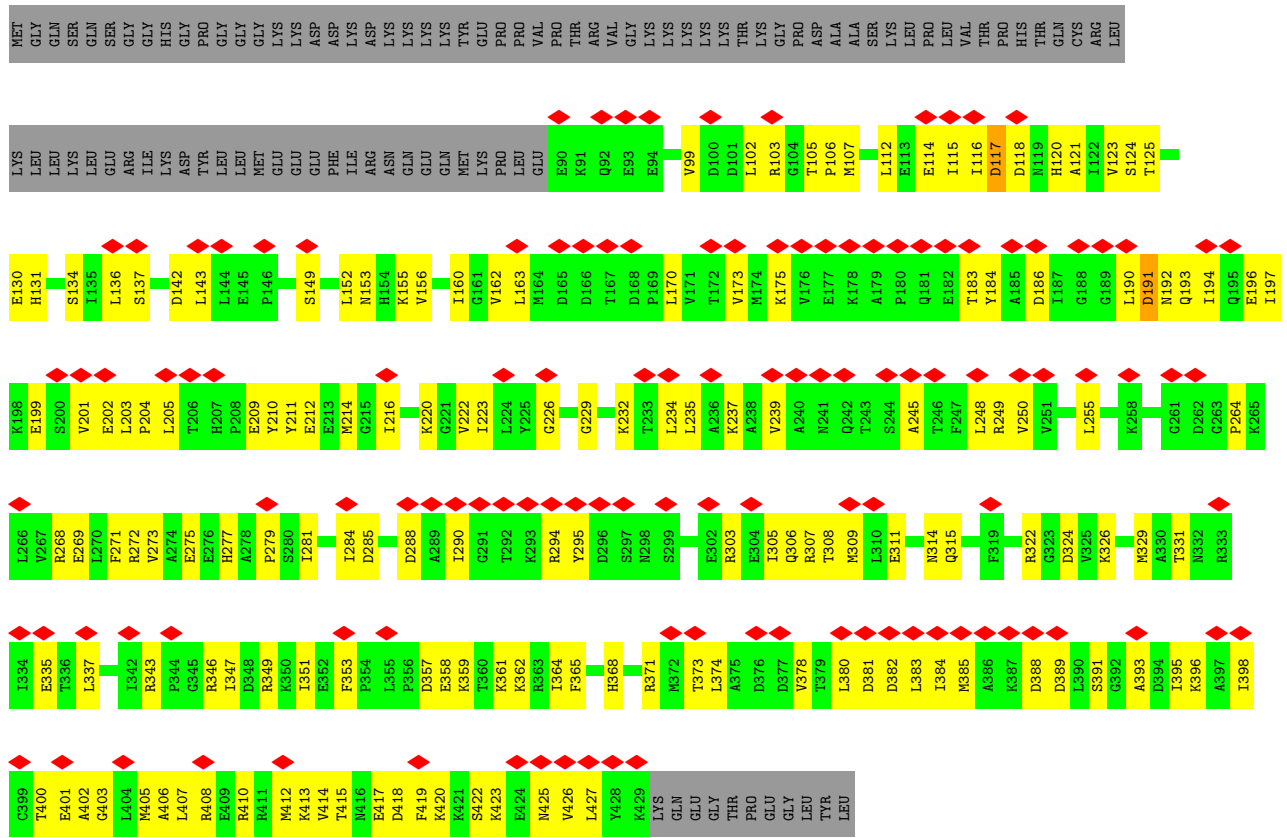

• Molecule 18: 26S proteasome regulatory subunit 10B

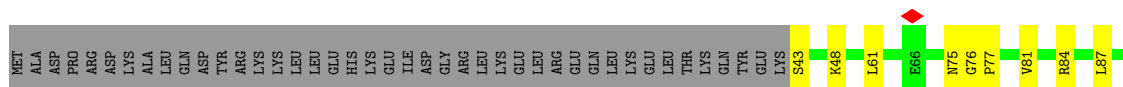





## 4 Experimental information

Property	Value	Source
EM reconstruction method	SINGLE PARTICLE	Depositor
Imposed symmetry	POINT, Not provided	
Number of particles used	7251	Depositor
Resolution determination method	FSC 0.143 CUT-OFF	Depositor
CTF correction method	PHASE FLIPPING AND AMPLITUDE CORRECTION	Depositor
Microscope	TFS KRIOS	Depositor
Voltage (kV)	300	Depositor
Electron dose ( $e^-/\text{\AA}^2$ )	40	Depositor
Minimum defocus (nm)	800	Depositor
Maximum defocus (nm)	1800	Depositor
Magnification	Not provided	
Image detector	GATAN K3 (6k x 4k)	Depositor
Maximum map value	0.243	Depositor
Minimum map value	-0.140	Depositor
Average map value	0.001	Depositor
Map value standard deviation	0.015	Depositor
Recommended contour level	0.06	Depositor
Map size (Å)	340.0, 340.0, 340.0	wwPDB
Map dimensions	400, 400, 400	wwPDB
Map angles (°)	90.0, 90.0, 90.0	wwPDB
Pixel spacing (Å)	0.85, 0.85, 0.85	Depositor

## 5 Model quality [i](#)

### 5.1 Standard geometry [i](#)

Bond lengths and bond angles in the following residue types are not validated in this section: ZN, ATP, ADP, MG

The Z score for a bond length (or angle) is the number of standard deviations the observed value is removed from the expected value. A bond length (or angle) with  $|Z| > 5$  is considered an outlier worth inspection. RMSZ is the root-mean-square of all Z scores of the bond lengths (or angles).

Mol	Chain	Bond lengths		Bond angles	
		RMSZ	# Z  >5	RMSZ	# Z  >5
1	f	0.22	0/1513	0.47	0/2046
2	C	0.20	0/2908	0.47	0/3912
3	D	0.21	0/3085	0.48	0/4163
4	V	0.20	0/3662	0.46	0/4946
5	W	0.20	0/3630	0.45	0/4884
6	X	0.16	0/3084	0.41	0/4157
7	Y	0.22	0/3160	0.52	0/4254
8	Z	0.21	0/2324	0.48	0/3150
9	a	0.18	0/3053	0.47	0/4133
10	b	0.18	0/1478	0.46	0/2001
11	d	0.22	0/2239	0.52	0/3025
12	e	0.19	0/420	0.42	0/572
14	U	0.18	0/6486	0.41	2/8777 (0.0%)
15	c	0.23	0/2347	0.48	0/3174
16	A	0.19	0/2914	0.44	0/3937
17	B	0.18	0/2684	0.47	0/3623
18	E	0.20	0/2765	0.46	0/3730
19	F	0.19	0/2942	0.45	0/3967
20	w	0.23	0/140	0.55	0/192
All	All	0.20	0/50834	0.46	2/68643 (0.0%)

Chiral center outliers are detected by calculating the chiral volume of a chiral center and verifying if the center is modelled as a planar moiety or with the opposite hand. A planarity outlier is detected by checking planarity of atoms in a peptide group, atoms in a mainchain group or atoms of a sidechain that are expected to be planar.

Mol	Chain	#Chirality outliers	#Planarity outliers
9	a	0	1

There are no bond length outliers.

All (2) bond angle outliers are listed below:

Mol	Chain	Res	Type	Atoms	Z	Observed(°)	Ideal(°)
14	U	685	GLN	CA-CB-CG	5.12	124.34	114.10
14	U	727	LYS	CA-CB-CG	5.06	124.21	114.10

There are no chirality outliers.

All (1) planarity outliers are listed below:

Mol	Chain	Res	Type	Group
9	a	221	VAL	Peptide

## 5.2 Too-close contacts [i](#)

In the following table, the Non-H and H(model) columns list the number of non-hydrogen atoms and hydrogen atoms in the chain respectively. The H(added) column lists the number of hydrogen atoms added and optimized by MolProbity. The Clashes column lists the number of clashes within the asymmetric unit, whereas Symm-Clashes lists symmetry-related clashes.

Mol	Chain	Non-H	H(model)	H(added)	Clashes	Symm-Clashes
1	f	1488	0	1509	100	0
2	C	2870	0	2976	162	0
3	D	3035	0	3070	147	0
4	V	3592	0	3647	191	0
5	W	3582	0	3693	159	0
6	X	3040	0	3134	116	0
7	Y	3103	0	3104	163	0
8	Z	2281	0	2312	109	0
9	a	2995	0	3012	148	0
10	b	1458	0	1505	68	0
11	d	2193	0	2221	111	0
12	e	409	0	316	18	0
13	v	35	0	9	2	0
14	U	6371	0	6409	248	0
15	c	2304	0	2315	115	0
16	A	2863	0	2895	136	0
17	B	2647	0	2684	137	0
18	E	2721	0	2770	106	0
19	F	2902	0	2957	146	0
20	w	135	0	137	24	0
21	C	27	0	12	7	0
21	F	27	0	12	3	0
22	A	31	0	12	4	0

*Continued on next page...*

Continued from previous page...

Mol	Chain	Non-H	H(model)	H(added)	Clashes	Symm-Clashes
22	B	31	0	12	6	0
22	D	31	0	12	9	0
22	E	31	0	12	1	0
23	c	1	0	0	0	0
24	B	1	0	0	0	0
24	E	1	0	0	0	0
24	F	1	0	0	0	0
All	All	50206	0	50747	2131	0

The all-atom clashscore is defined as the number of clashes found per 1000 atoms (including hydrogen atoms). The all-atom clashscore for this structure is 21.

The worst 5 of 2131 close contacts within the same asymmetric unit are listed below, sorted by their clash magnitude.

Atom-1	Atom-2	Interatomic distance (Å)	Clash overlap (Å)
14:U:685:GLN:HE21	14:U:725:MET:HB3	1.29	0.97
8:Z:263:ALA:HB1	15:c:288:VAL:HG23	1.46	0.93
17:B:223:ILE:HG12	17:B:329:MET:HB3	1.52	0.91
9:a:70:ARG:HD3	10:b:17:ARG:HH12	1.31	0.91
6:X:283:GLN:HG3	6:X:312:GLU:HG3	1.53	0.90

There are no symmetry-related clashes.

## 5.3 Torsion angles [i](#)

### 5.3.1 Protein backbone [i](#)

In the following table, the Percentiles column shows the percent Ramachandran outliers of the chain as a percentile score with respect to all PDB entries followed by that with respect to all EM entries.

The Analysed column shows the number of residues for which the backbone conformation was analysed, and the total number of residues.

Mol	Chain	Analysed	Favoured	Allowed	Outliers	Percentiles
1	f	192/856 (22%)	173 (90%)	19 (10%)	0	100 100
2	C	360/406 (89%)	334 (93%)	25 (7%)	1 (0%)	37 72
3	D	378/418 (90%)	351 (93%)	26 (7%)	1 (0%)	37 72
4	V	440/534 (82%)	414 (94%)	25 (6%)	1 (0%)	44 78

Continued on next page...

Continued from previous page...

Mol	Chain	Analysed	Favoured	Allowed	Outliers	Percentiles	
5	W	438/456 (96%)	416 (95%)	22 (5%)	0	100	100
6	X	382/422 (90%)	364 (95%)	17 (4%)	1 (0%)	37	72
7	Y	372/389 (96%)	348 (94%)	23 (6%)	1 (0%)	37	72
8	Z	284/324 (88%)	273 (96%)	10 (4%)	1 (0%)	30	67
9	a	371/376 (99%)	338 (91%)	31 (8%)	2 (0%)	25	63
10	b	189/377 (50%)	168 (89%)	19 (10%)	2 (1%)	12	46
11	d	268/350 (77%)	248 (92%)	18 (7%)	2 (1%)	19	56
12	e	46/70 (66%)	35 (76%)	11 (24%)	0	100	100
14	U	812/953 (85%)	771 (95%)	41 (5%)	0	100	100
15	c	291/590 (49%)	279 (96%)	11 (4%)	1 (0%)	37	72
16	A	364/433 (84%)	330 (91%)	33 (9%)	1 (0%)	37	72
17	B	338/440 (77%)	310 (92%)	26 (8%)	2 (1%)	22	59
18	E	345/389 (89%)	318 (92%)	27 (8%)	0	100	100
19	F	370/439 (84%)	344 (93%)	25 (7%)	1 (0%)	37	72
20	w	15/337 (4%)	13 (87%)	2 (13%)	0	100	100
All	All	6255/8559 (73%)	5827 (93%)	411 (7%)	17 (0%)	38	72

5 of 17 Ramachandran outliers are listed below:

Mol	Chain	Res	Type
7	Y	98	SER
8	Z	149	THR
15	c	262	GLU
16	A	82	ALA
17	B	117	ASP

### 5.3.2 Protein sidechains [i](#)

In the following table, the Percentiles column shows the percent sidechain outliers of the chain as a percentile score with respect to all PDB entries followed by that with respect to all EM entries.

The Analysed column shows the number of residues for which the sidechain conformation was analysed, and the total number of residues.

Mol	Chain	Analysed	Rotameric	Outliers	Percentiles	
1	f	165/690 (24%)	165 (100%)	0	100	100

Continued on next page...

*Continued from previous page...*

Mol	Chain	Analysed	Rotameric	Outliers	Percentiles	
2	C	315/352 (90%)	314 (100%)	1 (0%)	91	92
3	D	332/366 (91%)	332 (100%)	0	100	100
4	V	388/460 (84%)	387 (100%)	1 (0%)	91	92
5	W	404/416 (97%)	404 (100%)	0	100	100
6	X	330/362 (91%)	330 (100%)	0	100	100
7	Y	333/344 (97%)	333 (100%)	0	100	100
8	Z	257/295 (87%)	256 (100%)	1 (0%)	89	91
9	a	333/336 (99%)	333 (100%)	0	100	100
10	b	167/312 (54%)	167 (100%)	0	100	100
11	d	237/294 (81%)	237 (100%)	0	100	100
12	e	43/63 (68%)	43 (100%)	0	100	100
14	U	695/816 (85%)	695 (100%)	0	100	100
15	c	257/500 (51%)	257 (100%)	0	100	100
16	A	310/372 (83%)	309 (100%)	1 (0%)	91	92
17	B	296/385 (77%)	295 (100%)	1 (0%)	91	92
18	E	298/341 (87%)	298 (100%)	0	100	100
19	F	316/379 (83%)	315 (100%)	1 (0%)	91	92
20	w	15/289 (5%)	15 (100%)	0	100	100
All	All	5491/7372 (74%)	5485 (100%)	6 (0%)	92	94

5 of 6 residues with a non-rotameric sidechain are listed below:

Mol	Chain	Res	Type
16	A	403	ILE
17	B	125	THR
19	F	416	THR
4	V	469	THR
2	C	109	THR

Sometimes sidechains can be flipped to improve hydrogen bonding and reduce clashes. 5 of 118 such sidechains are listed below:

Mol	Chain	Res	Type
9	a	164	GLN
19	F	83	ASN
12	e	63	HIS

*Continued on next page...*

*Continued from previous page...*

Mol	Chain	Res	Type
19	F	76	ASN
15	c	298	GLN

### 5.3.3 RNA [i](#)

There are no RNA molecules in this entry.

### 5.4 Non-standard residues in protein, DNA, RNA chains [i](#)

There are no non-standard protein/DNA/RNA residues in this entry.

### 5.5 Carbohydrates [i](#)

There are no oligosaccharides in this entry.

### 5.6 Ligand geometry [i](#)

Of 10 ligands modelled in this entry, 4 are monoatomic - leaving 6 for Mogul analysis.

In the following table, the Counts columns list the number of bonds (or angles) for which Mogul statistics could be retrieved, the number of bonds (or angles) that are observed in the model and the number of bonds (or angles) that are defined in the Chemical Component Dictionary. The Link column lists molecule types, if any, to which the group is linked. The Z score for a bond length (or angle) is the number of standard deviations the observed value is removed from the expected value. A bond length (or angle) with  $|Z| > 2$  is considered an outlier worth inspection. RMSZ is the root-mean-square of all Z scores of the bond lengths (or angles).

Mol	Type	Chain	Res	Link	Bond lengths			Bond angles		
					Counts	RMSZ	# $ Z  > 2$	Counts	RMSZ	# $ Z  > 2$
22	ATP	D	501	-	26,33,33	0.61	0	31,52,52	0.82	2 (6%)
22	ATP	B	501	24	26,33,33	0.62	0	31,52,52	0.78	1 (3%)
22	ATP	A	501	-	26,33,33	0.61	0	31,52,52	0.77	2 (6%)
21	ADP	F	501	24	24,29,29	0.96	1 (4%)	29,45,45	1.50	4 (13%)
21	ADP	C	501	-	24,29,29	0.67	0	29,45,45	0.76	1 (3%)
22	ATP	E	401	24	26,33,33	0.61	0	31,52,52	0.75	2 (6%)

In the following table, the Chirals column lists the number of chiral outliers, the number of chiral centers analysed, the number of these observed in the model and the number defined in the Chemical Component Dictionary. Similar counts are reported in the Torsion and Rings columns.

'-' means no outliers of that kind were identified.

Mol	Type	Chain	Res	Link	Chirals	Torsions	Rings
22	ATP	D	501	-	-	7/18/38/38	0/3/3/3
22	ATP	B	501	24	-	5/18/38/38	0/3/3/3
22	ATP	A	501	-	-	2/18/38/38	0/3/3/3
21	ADP	F	501	24	-	3/12/32/32	0/3/3/3
21	ADP	C	501	-	-	3/12/32/32	0/3/3/3
22	ATP	E	401	24	-	7/18/38/38	0/3/3/3

All (1) bond length outliers are listed below:

Mol	Chain	Res	Type	Atoms	Z	Observed(Å)	Ideal(Å)
21	F	501	ADP	C5-C4	2.43	1.47	1.40

The worst 5 of 12 bond angle outliers are listed below:

Mol	Chain	Res	Type	Atoms	Z	Observed(°)	Ideal(°)
21	F	501	ADP	PA-O3A-PB	-3.57	120.58	132.83
21	F	501	ADP	C3'-C2'-C1'	3.53	106.30	100.98
21	F	501	ADP	N3-C2-N1	-3.29	123.53	128.68
21	F	501	ADP	C4-C5-N7	-2.53	106.76	109.40
22	B	501	ATP	C5-C6-N6	2.33	123.89	120.35

There are no chirality outliers.

5 of 27 torsion outliers are listed below:

Mol	Chain	Res	Type	Atoms
21	C	501	ADP	O4'-C4'-C5'-O5'
21	F	501	ADP	C5'-O5'-PA-O1A
21	F	501	ADP	C5'-O5'-PA-O2A
22	D	501	ATP	PB-O3B-PG-O2G
22	D	501	ATP	C5'-O5'-PA-O1A

There are no ring outliers.

6 monomers are involved in 30 short contacts:

Mol	Chain	Res	Type	Clashes	Symm-Clashes
22	D	501	ATP	9	0
22	B	501	ATP	6	0
22	A	501	ATP	4	0
21	F	501	ADP	3	0

*Continued on next page...*

Continued from previous page...

Mol	Chain	Res	Type	Clashes	Symm-Clashes
21	C	501	ADP	7	0
22	E	401	ATP	1	0

The following is a two-dimensional graphical depiction of Mogul quality analysis of bond lengths, bond angles, torsion angles, and ring geometry for all instances of the Ligand of Interest. In addition, ligands with molecular weight > 250 and outliers as shown on the validation Tables will also be included. For torsion angles, if less than 5% of the Mogul distribution of torsion angles is within 10 degrees of the torsion angle in question, then that torsion angle is considered an outlier. Any bond that is central to one or more torsion angles identified as an outlier by Mogul will be highlighted in the graph. For rings, the root-mean-square deviation (RMSD) between the ring in question and similar rings identified by Mogul is calculated over all ring torsion angles. If the average RMSD is greater than 60 degrees and the minimal RMSD between the ring in question and any Mogul-identified rings is also greater than 60 degrees, then that ring is considered an outlier. The outliers are highlighted in purple. The color gray indicates Mogul did not find sufficient equivalents in the CSD to analyse the geometry.

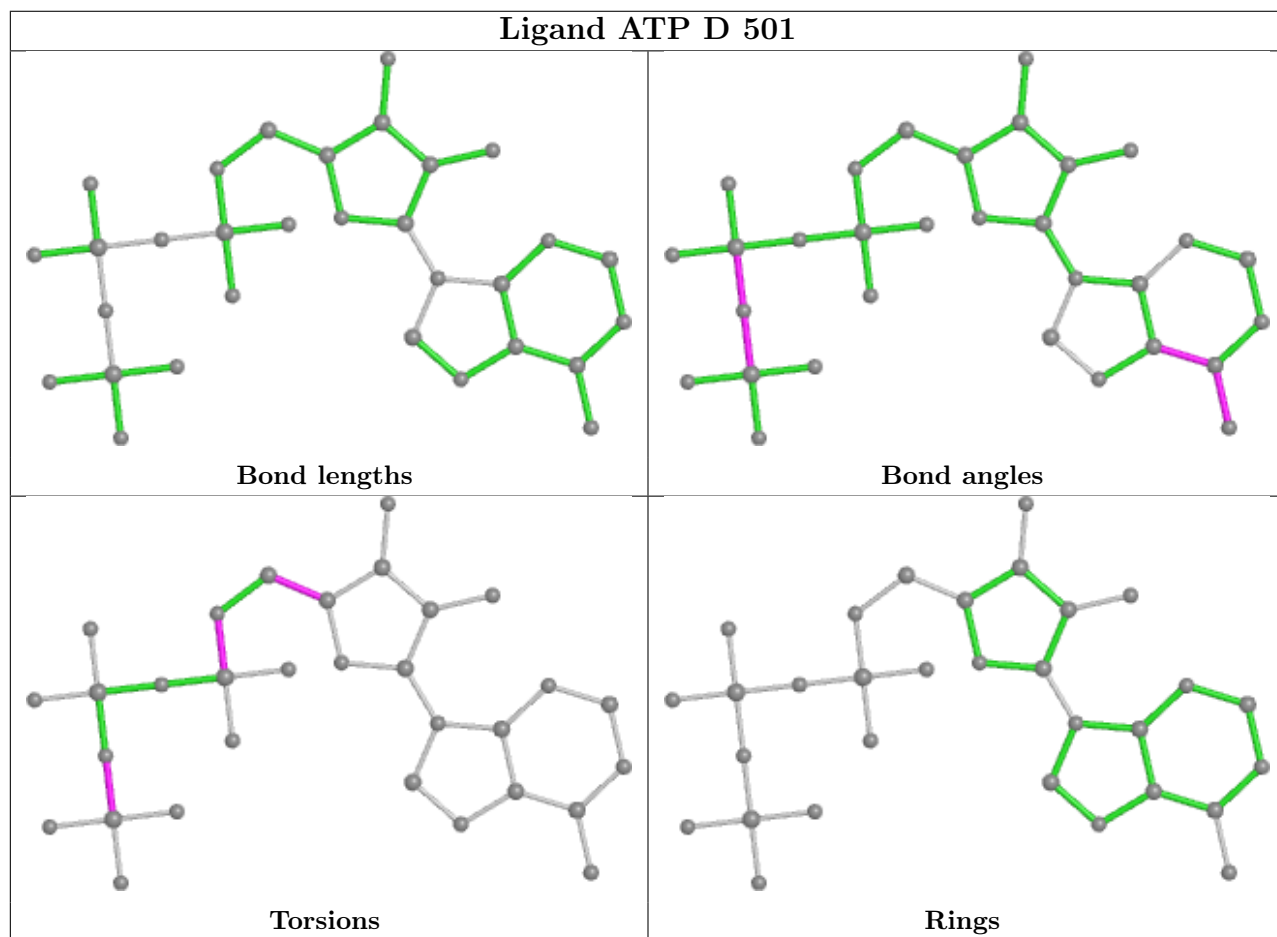

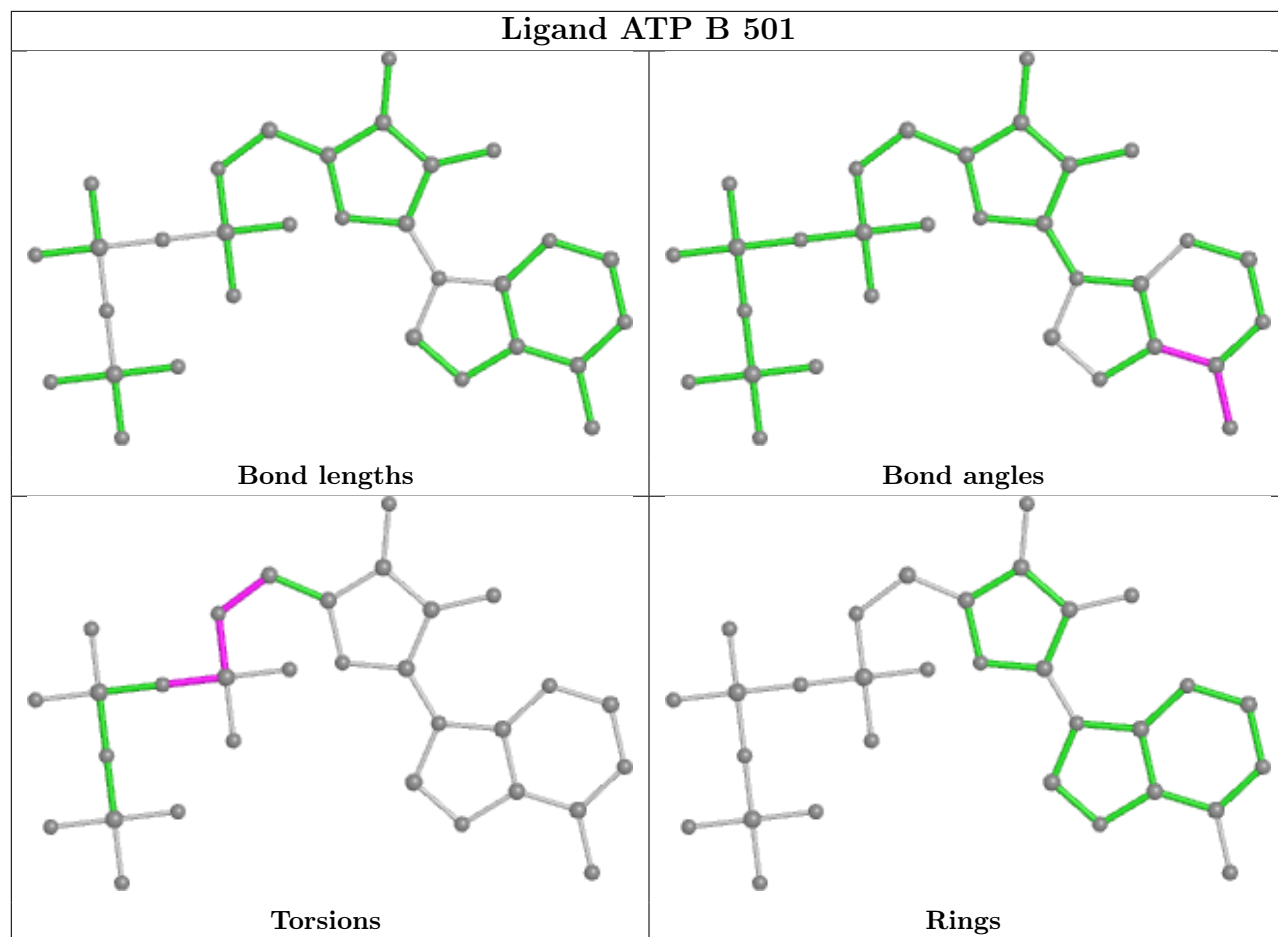

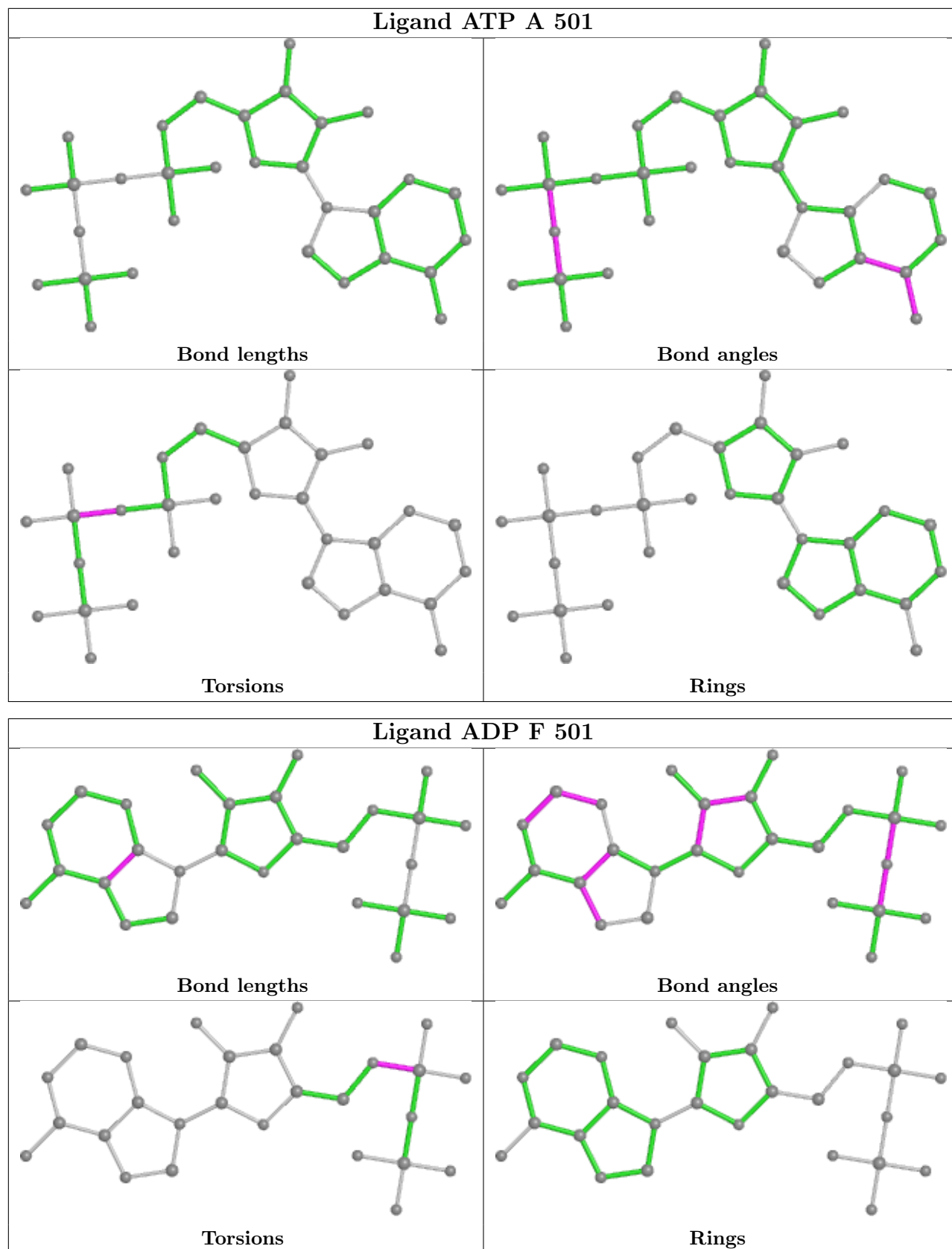

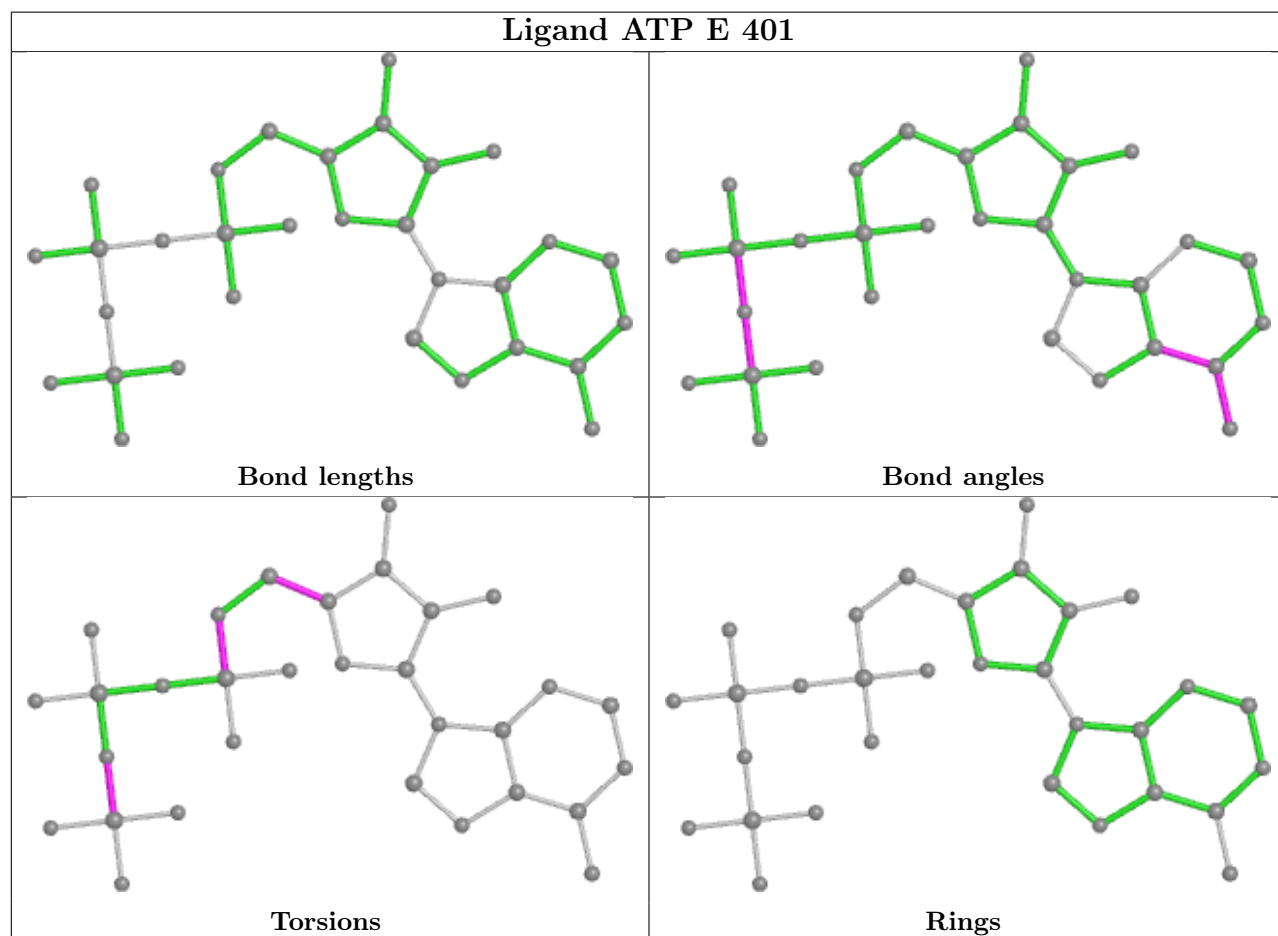
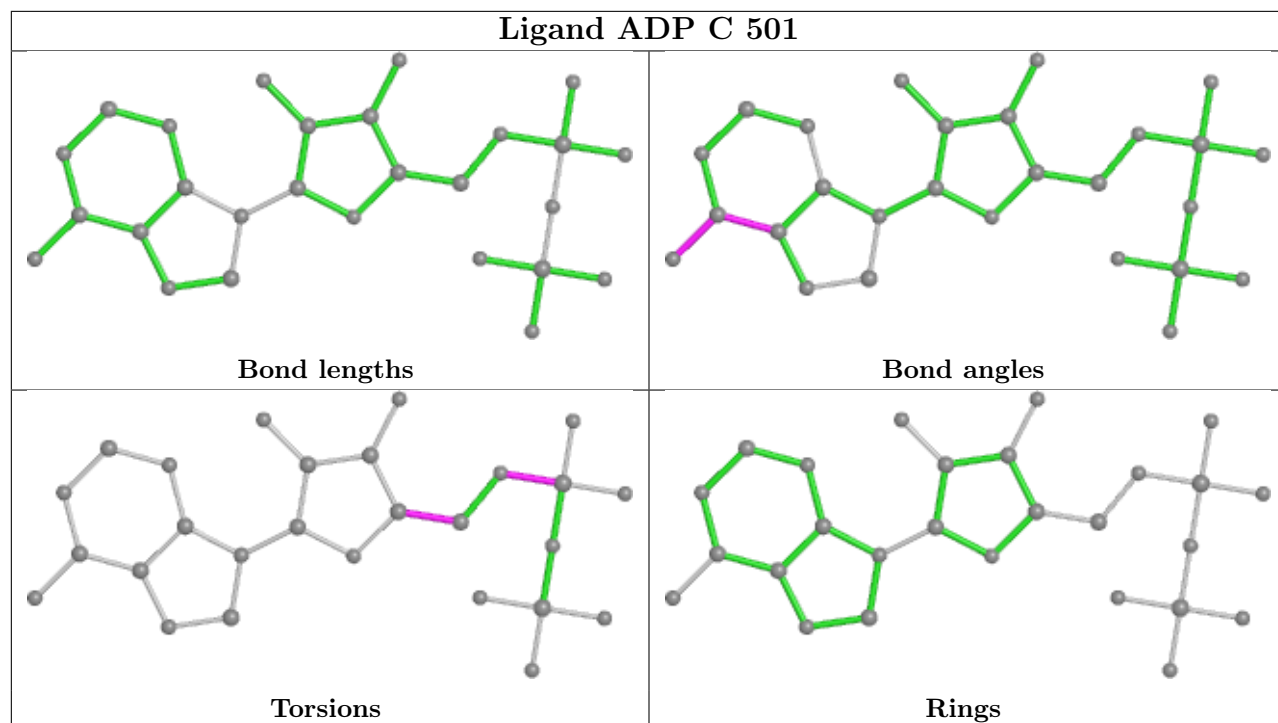

## 5.7 Other polymers [i](#)

There are no such residues in this entry.

## 5.8 Polymer linkage issues [i](#)

There are no chain breaks in this entry.

## 6 Map visualisation [i](#)

This section contains visualisations of the EMDB entry EMD-65839. These allow visual inspection of the internal detail of the map and identification of artifacts.

Images derived from a raw map, generated by summing the deposited half-maps, are presented below the corresponding image components of the primary map to allow further visual inspection and comparison with those of the primary map.

### 6.1 Orthogonal projections [i](#)

#### 6.1.1 Primary map

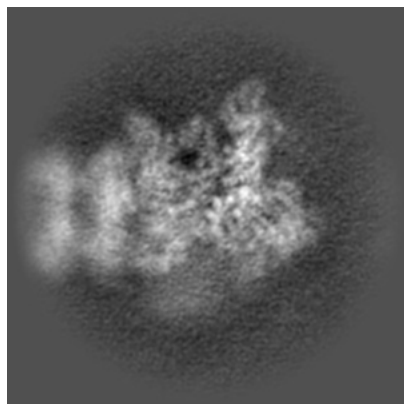

X

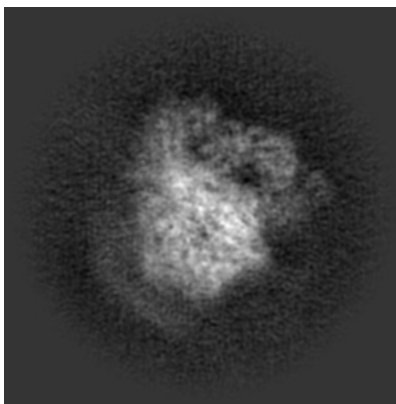

Y

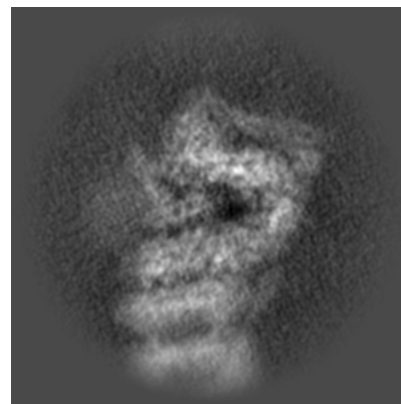

Z

#### 6.1.2 Raw map

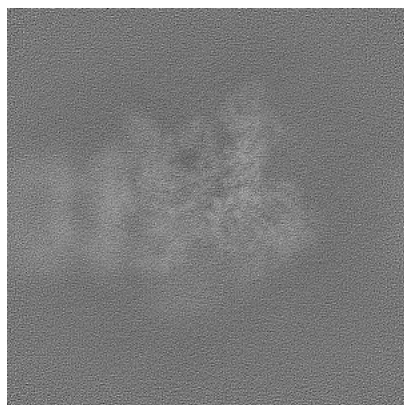

X

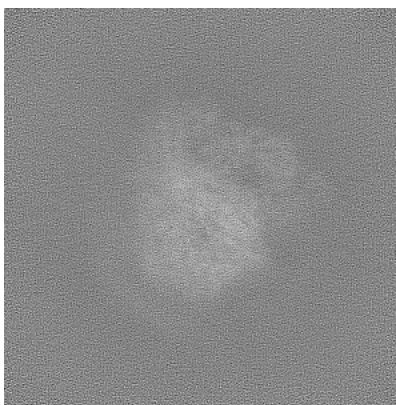

Y

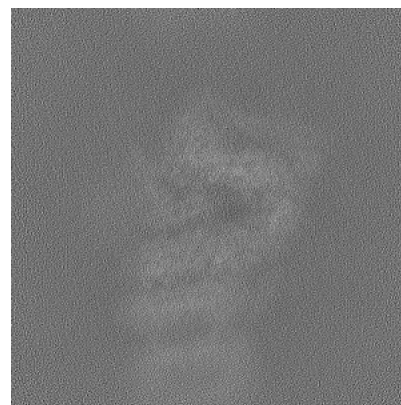

Z

The images above show the map projected in three orthogonal directions.

## 6.2 Central slices [i](#)

### 6.2.1 Primary map

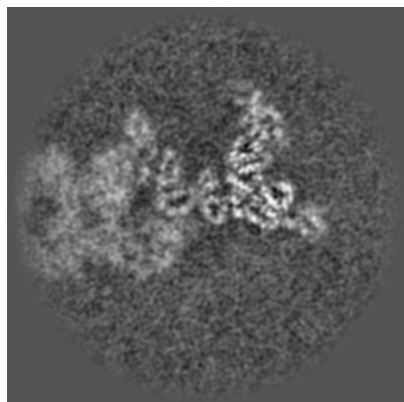

X Index: 200

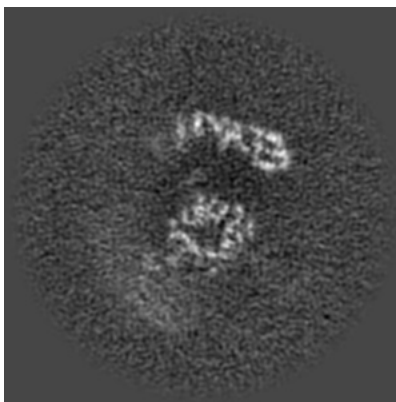

Y Index: 200

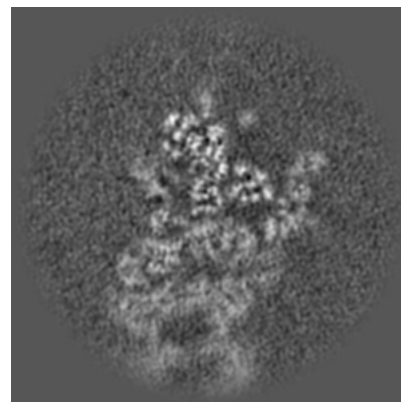

Z Index: 200

### 6.2.2 Raw map

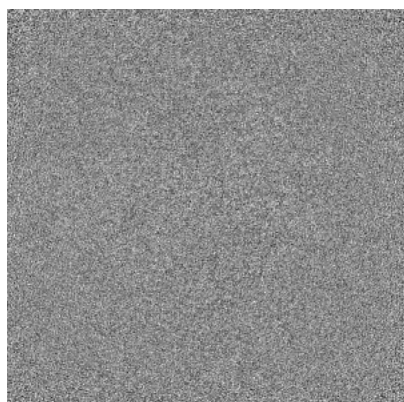

X Index: 200

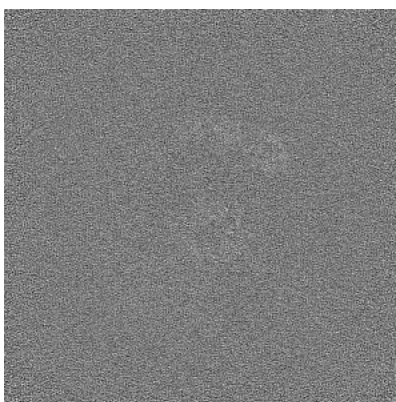

Y Index: 200

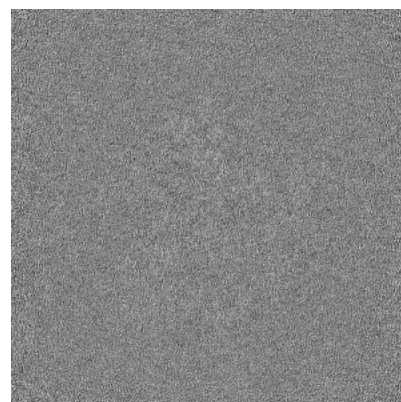

Z Index: 200

The images above show central slices of the map in three orthogonal directions.

## 6.3 Largest variance slices [i](#)

### 6.3.1 Primary map

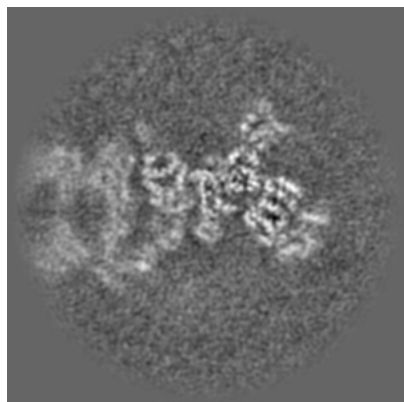

X Index: 185

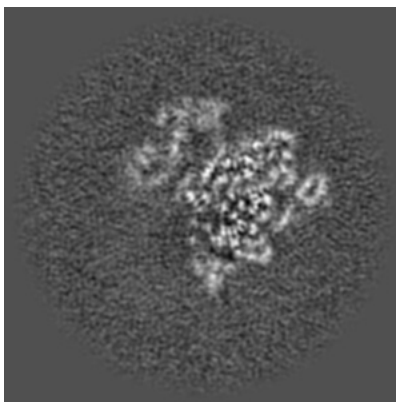

Y Index: 237

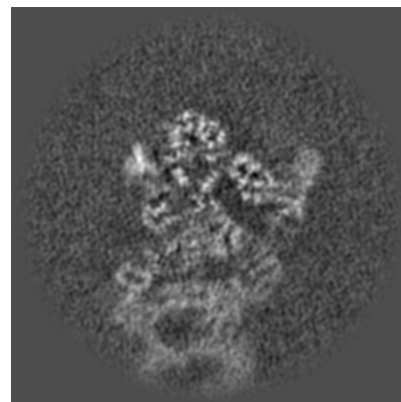

Z Index: 209

### 6.3.2 Raw map

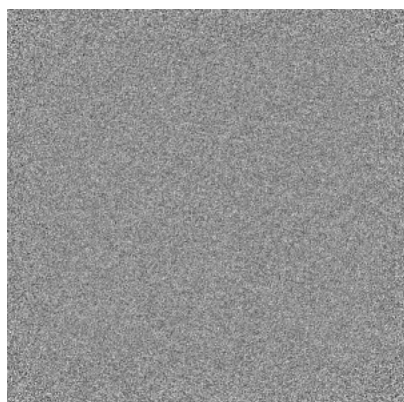

X Index: 0

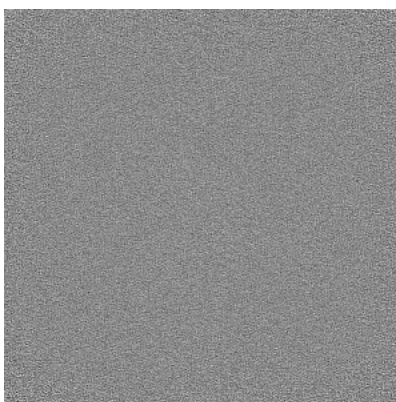

Y Index: 0

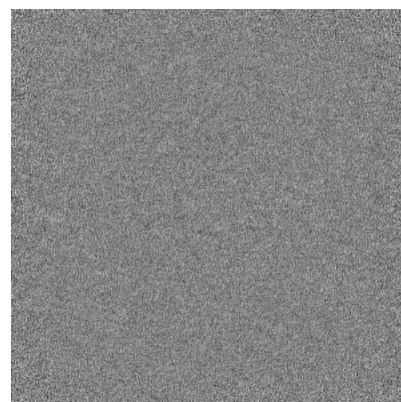

Z Index: 0

The images above show the largest variance slices of the map in three orthogonal directions.

## 6.4 Orthogonal standard-deviation projections (False-color) [i](#)

### 6.4.1 Primary map

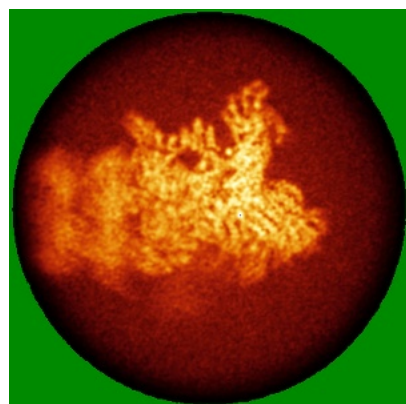

X

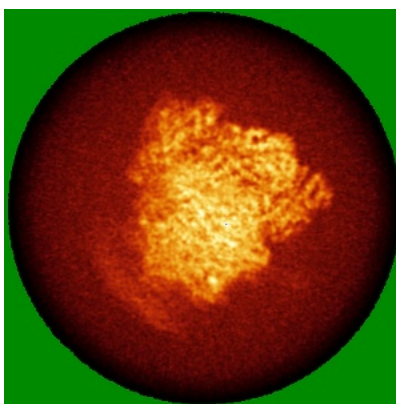

Y

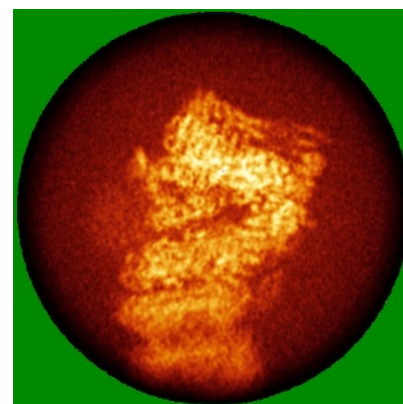

Z

### 6.4.2 Raw map

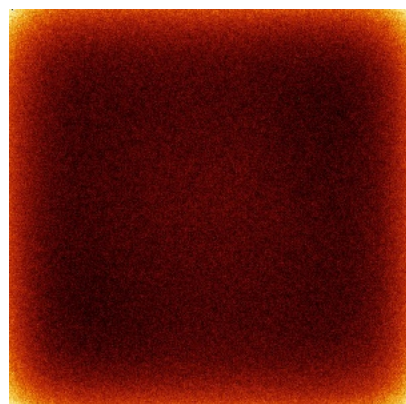

X

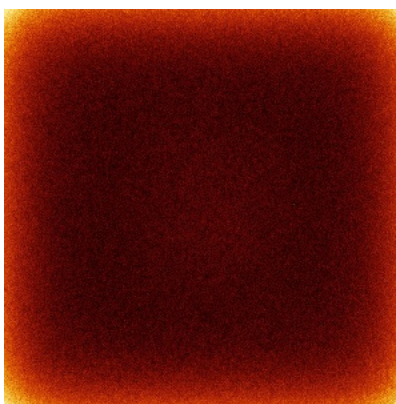

Y

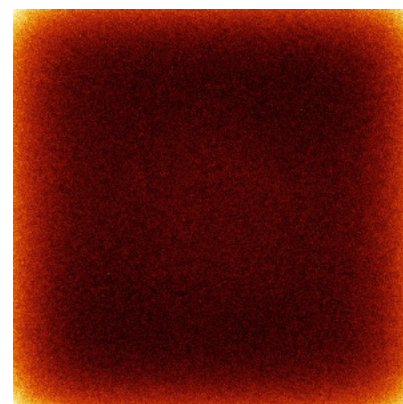

Z

The images above show the map standard deviation projections with false color in three orthogonal directions. Minimum values are shown in green, max in blue, and dark to light orange shades represent small to large values respectively.

## 6.5 Orthogonal surface views [i](#)

### 6.5.1 Primary map

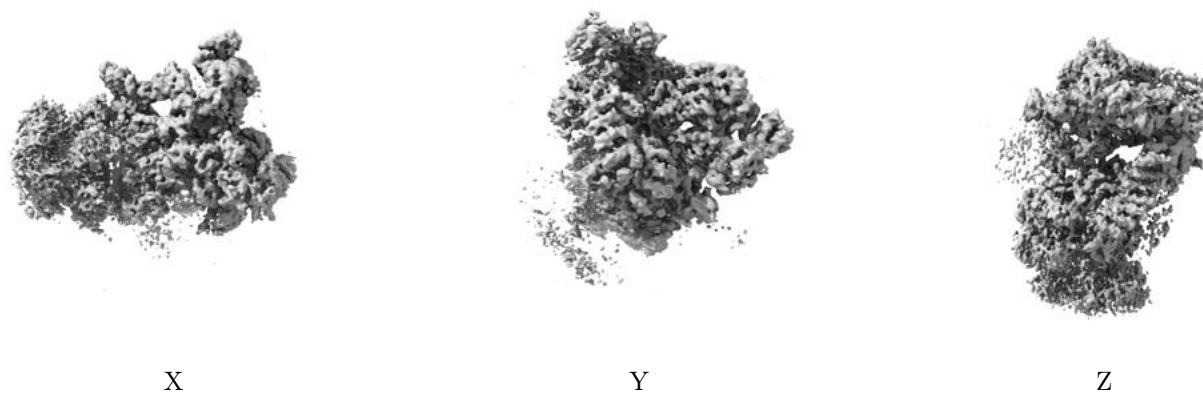

The images above show the 3D surface view of the map at the recommended contour level 0.06. These images, in conjunction with the slice images, may facilitate assessment of whether an appropriate contour level has been provided.

### 6.5.2 Raw map

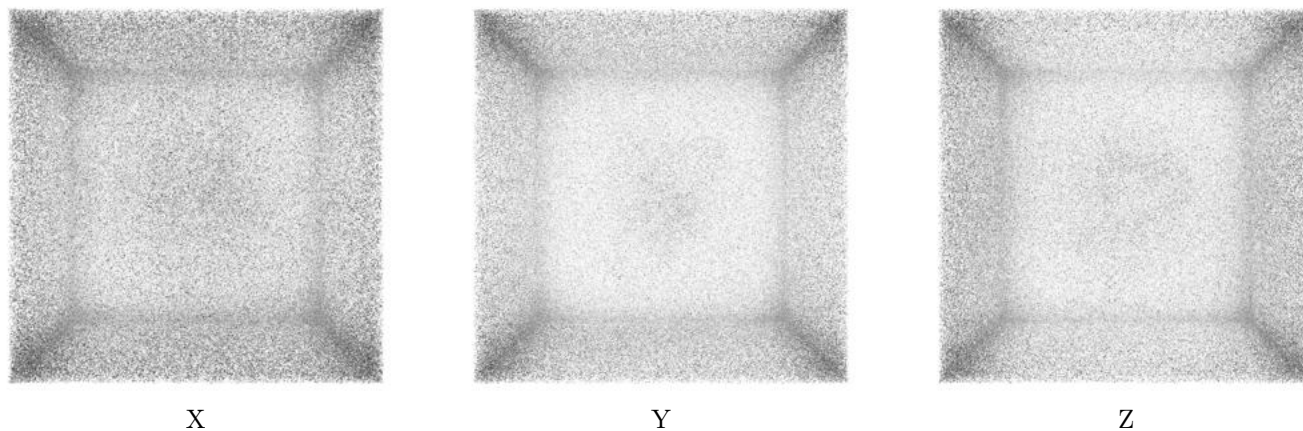

These images show the 3D surface of the raw map. The raw map's contour level was selected so that its surface encloses the same volume as the primary map does at its recommended contour level.

## 6.6 Mask visualisation [i](#)

This section was not generated. No masks/segmentation were deposited.

## 7 Map analysis [i](#)

This section contains the results of statistical analysis of the map.

### 7.1 Map-value distribution [i](#)

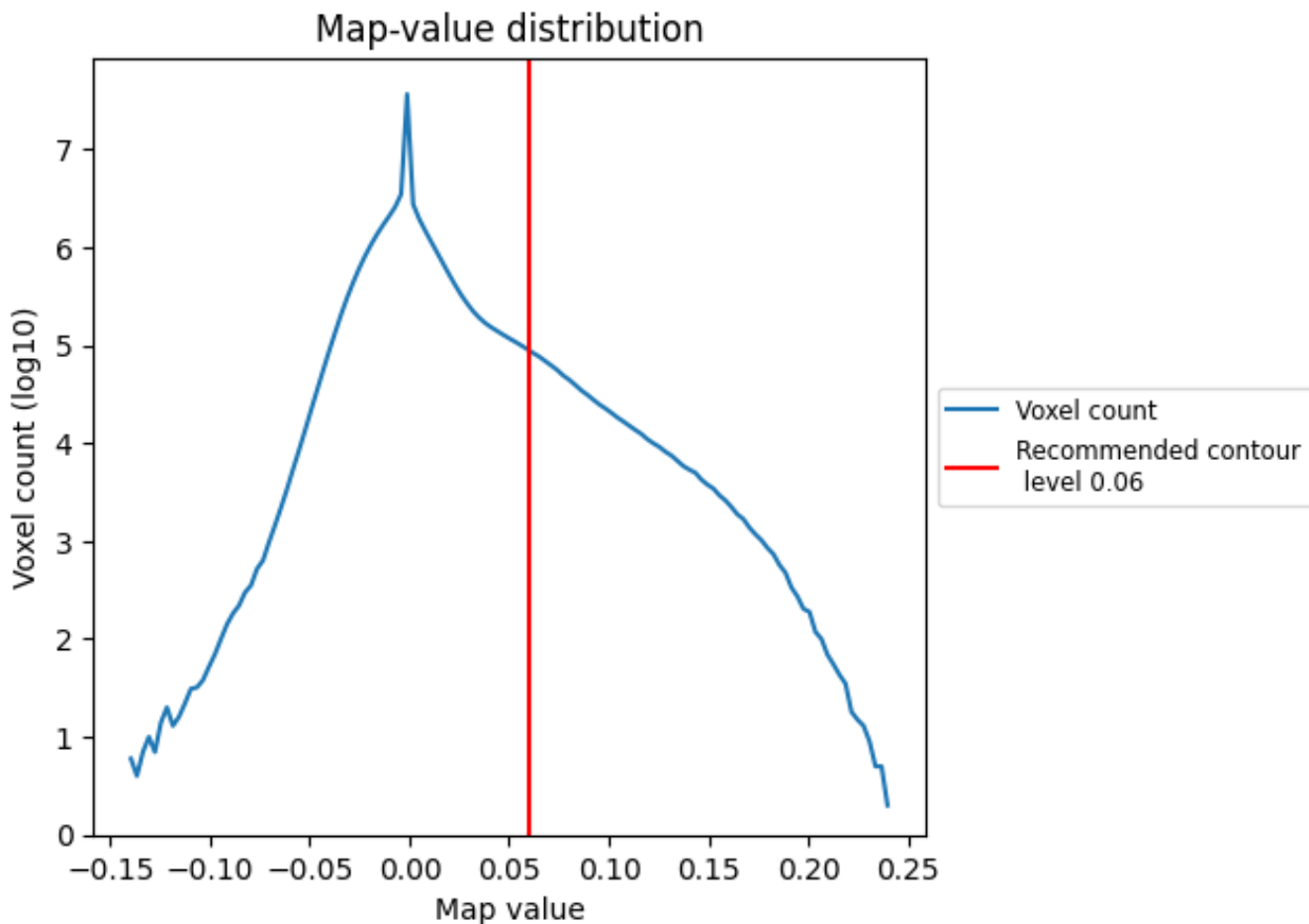

The map-value distribution is plotted in 128 intervals along the x-axis. The y-axis is logarithmic. A spike in this graph at zero usually indicates that the volume has been masked.

## 7.2 Volume estimate [\(i\)](#)

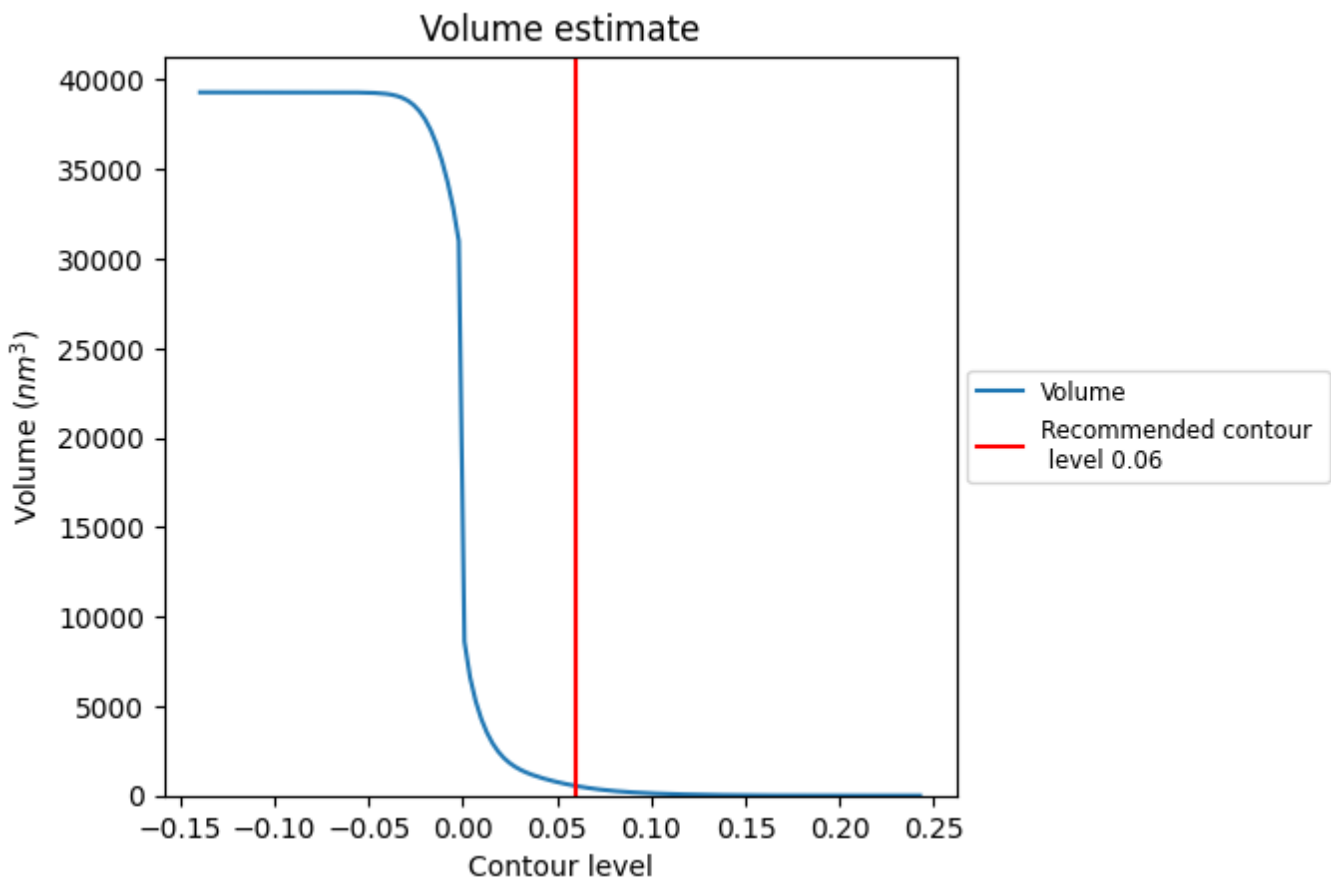

The volume at the recommended contour level is 538 nm<sup>3</sup>; this corresponds to an approximate mass of 486 kDa.

The volume estimate graph shows how the enclosed volume varies with the contour level. The recommended contour level is shown as a vertical line and the intersection between the line and the curve gives the volume of the enclosed surface at the given level.

### 7.3 Rotationally averaged power spectrum i

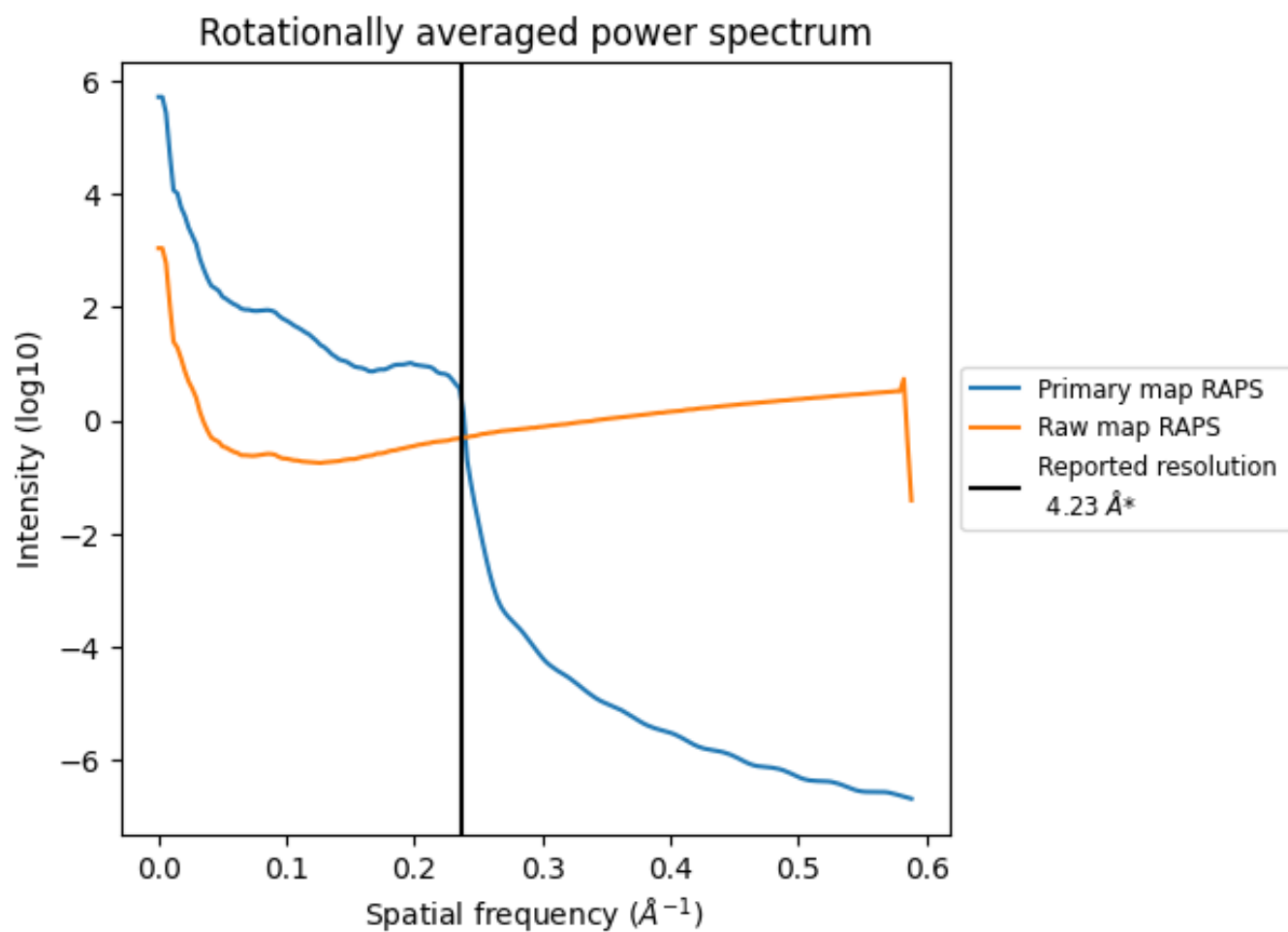

\*Reported resolution corresponds to spatial frequency of 0.236 Å<sup>-1</sup>

## 8 Fourier-Shell correlation [i](#)

Fourier-Shell Correlation (FSC) is the most commonly used method to estimate the resolution of single-particle and subtomogram-averaged maps. The shape of the curve depends on the imposed symmetry, mask and whether or not the two 3D reconstructions used were processed from a common reference. The reported resolution is shown as a black line. A curve is displayed for the half-bit criterion in addition to lines showing the 0.143 gold standard cut-off and 0.5 cut-off.

### 8.1 FSC [i](#)

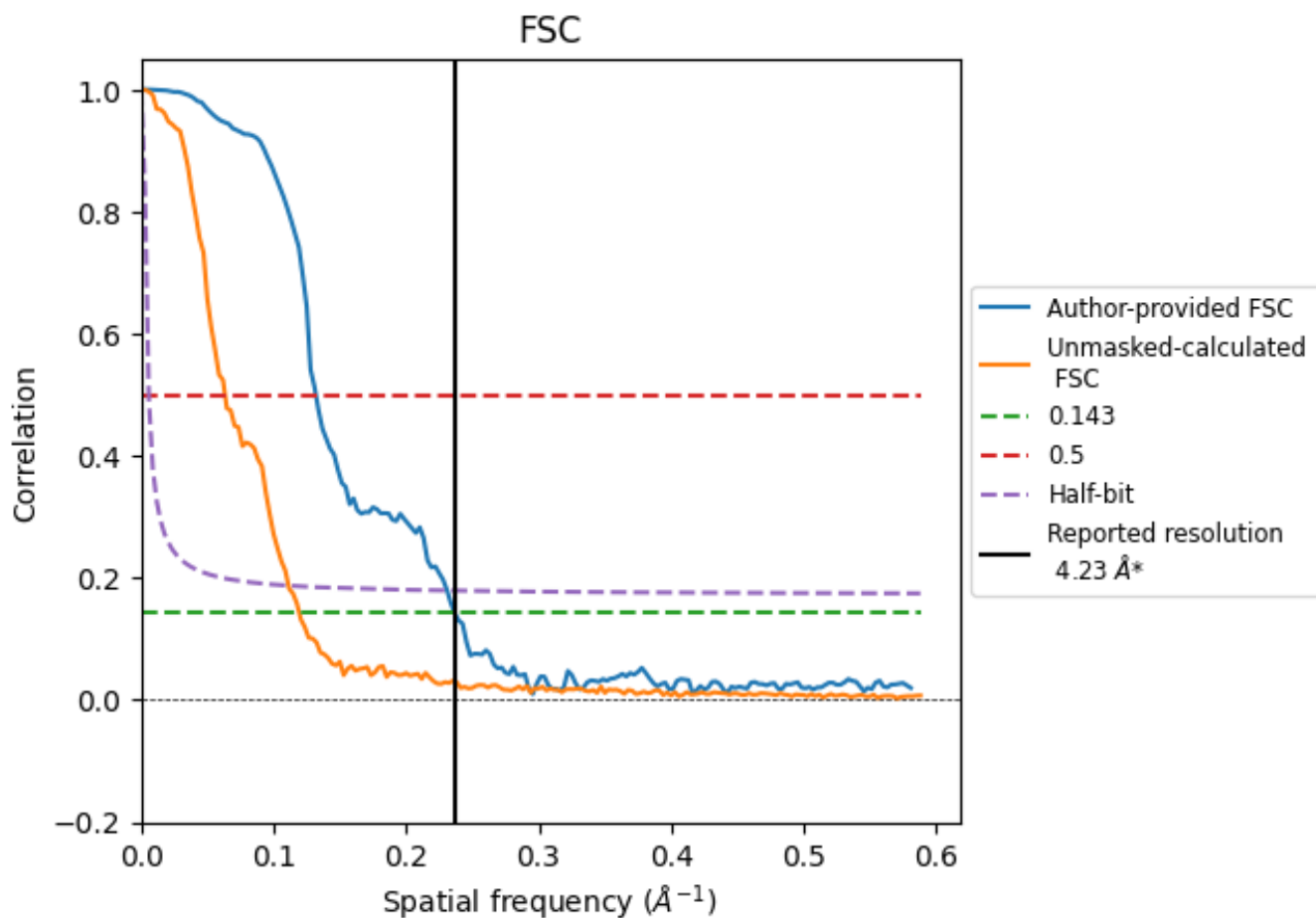

\*Reported resolution corresponds to spatial frequency of 0.236 Å<sup>-1</sup>

## 8.2 Resolution estimates [i](#)

Resolution estimate (Å)	Estimation criterion (FSC cut-off)		
	0.143	0.5	Half-bit
Reported by author	4.23	-	-
Author-provided FSC curve	4.23	7.58	4.33
Unmasked-calculated*	8.38	15.80	8.98

\*Resolution estimate based on FSC curve calculated by comparison of deposited half-maps. The value from deposited half-maps intersecting FSC 0.143 CUT-OFF 8.38 differs from the reported value 4.23 by more than 10 %

## 9 Map-model fit [i](#)

This section contains information regarding the fit between EMDB map EMD-65839 and PDB model 9WBG. Per-residue inclusion information can be found in section 3 on page 11.

### 9.1 Map-model overlay [i](#)

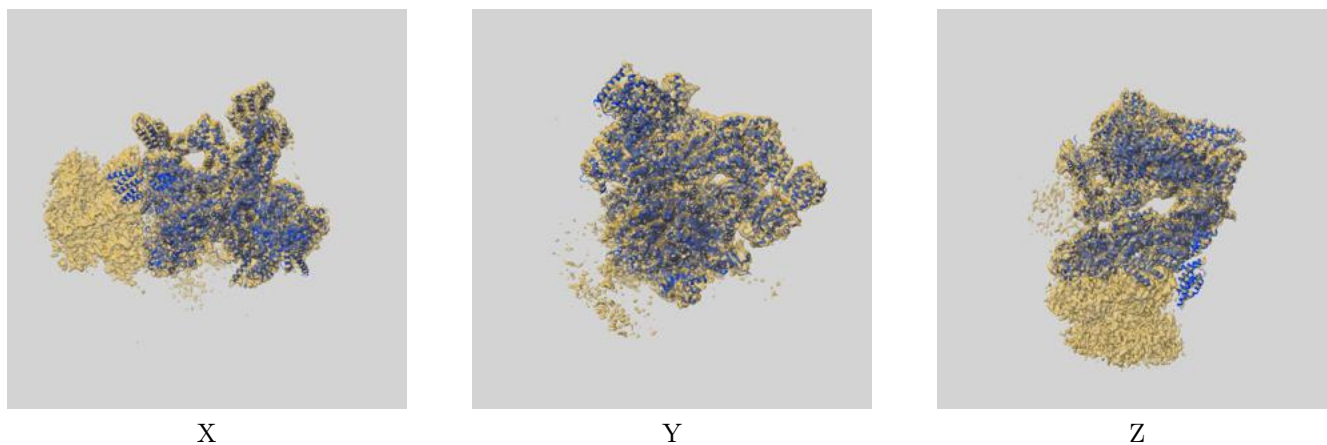

The images above show the 3D surface view of the map at the recommended contour level 0.06 at 50% transparency in yellow overlaid with a ribbon representation of the model coloured in blue. These images allow for the visual assessment of the quality of fit between the atomic model and the map.

## 9.2 Q-score mapped to coordinate model [i](#)

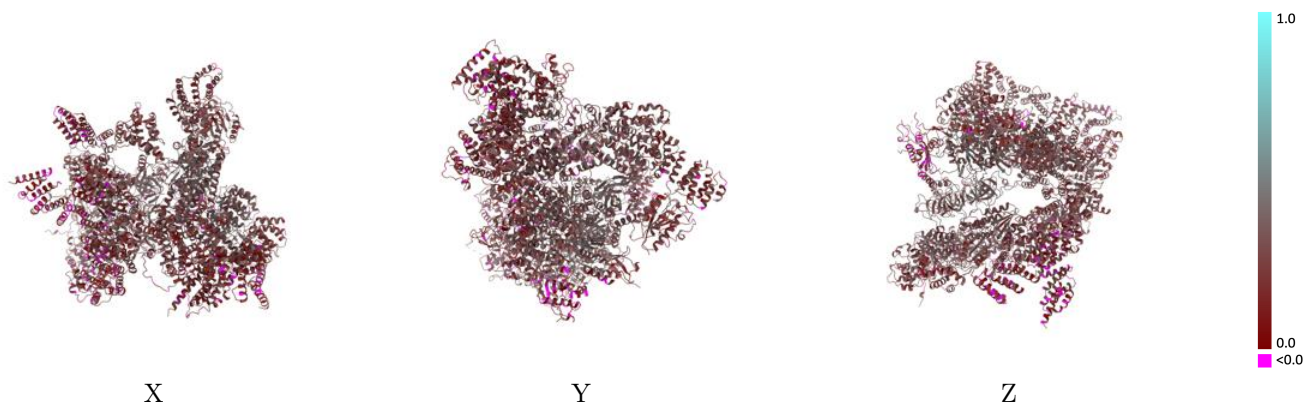

The images above show the model with each residue coloured according to its Q-score. This shows their resolvability in the map with higher Q-score values reflecting better resolvability. Please note: Q-score is calculating the resolvability of atoms, and thus high values are only expected at resolutions at which atoms can be resolved. Low Q-score values may therefore be expected for many entries.

## 9.3 Atom inclusion mapped to coordinate model [i](#)

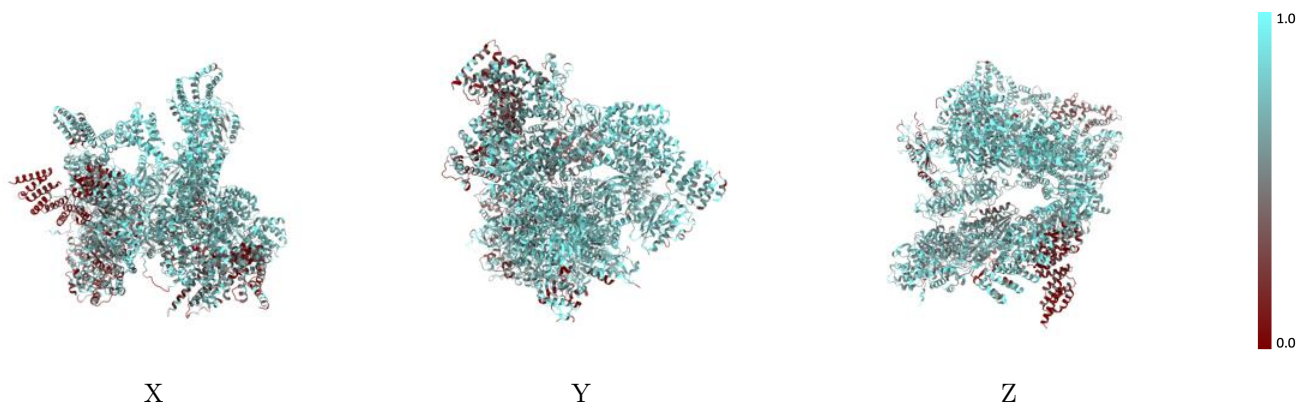

The images above show the model with each residue coloured according to its atom inclusion. This shows to what extent they are inside the map at the recommended contour level (0.06).



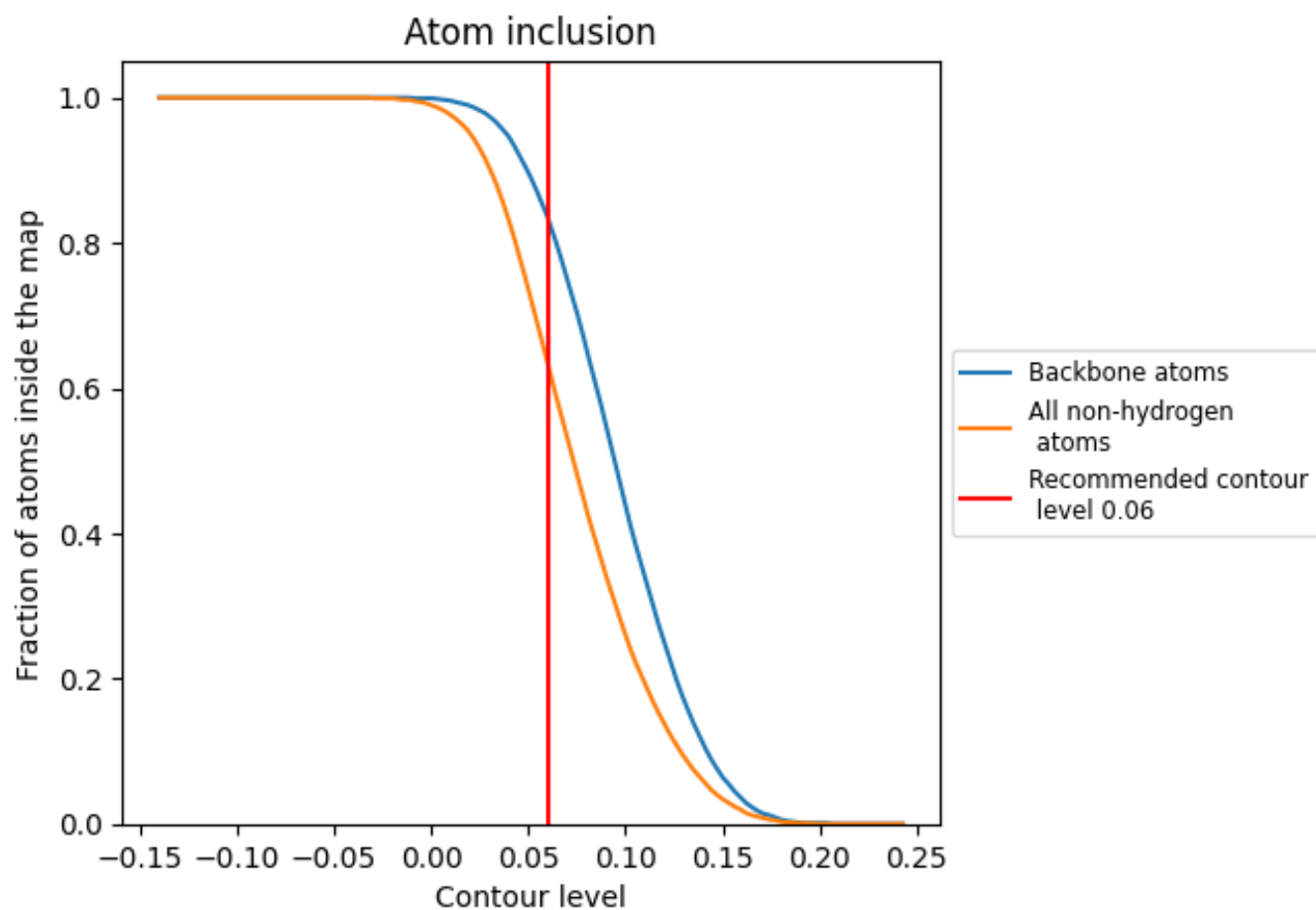







































## 9.4 Atom inclusion [i](#)



At the recommended contour level, 84% of all backbone atoms, 64% of all non-hydrogen atoms, are inside the map.

## 9.5 Map-model fit summary

The table lists the average atom inclusion at the recommended contour level (0.06) and Q-score for the entire model and for each chain.

Chain	Atom inclusion	Q-score
All	 0.6360	 0.2640
A	 0.6030	 0.2740
B	 0.4960	 0.2290
C	 0.5620	 0.2490
D	 0.6650	 0.2980
E	 0.7090	 0.3010
F	 0.6790	 0.2810
U	 0.7130	 0.2900
V	 0.5720	 0.2370
W	 0.7340	 0.2460
X	 0.3140	 0.1850
Y	 0.5940	 0.2320
Z	 0.7600	 0.3450
a	 0.7730	 0.2820
b	 0.7090	 0.2610
c	 0.7500	 0.3540
d	 0.5030	 0.2090
e	 0.5790	 0.2180
f	 0.6460	 0.1890
v	 0.4000	 0.3180
w	 0.6460	 0.1450

