



wwPDB EM Validation Summary Report ⓘ

Mar 27, 2026 – 06:16 AM UTC

PDB ID : 9N4Q / pdb_00009n4q
EMDB ID : EMD-48902
Title : Composite map for GluK2-2xNeto2 in the apo state
Authors : Gangwar, S.P.; Yelshanskaya, M.V.; Yen, L.Y.; Newton, T.P.; Sobolevsky, A.I.
Deposited on : 2025-02-03
Resolution : 3.48 Å (reported)

This is a wwPDB EM Validation Summary Report for a publicly released PDB entry.

We welcome your comments at validation@mail.wwpdb.org

A user guide is available at

<https://www.wwpdb.org/validation/2017/EMValidationReportHelp>

with specific help available everywhere you see the ⓘ symbol.

The types of validation reports are described at

<http://www.wwpdb.org/validation/2017/FAQs#types>.

The following versions of software and data (see [references ⓘ](#)) were used in the production of this report:

EMDB validation analysis : 0.0.1.dev132
Mogul : 2022.3.0, CSD as543be (2022)
MolProbity : 4-5-2 with Phenix2.0
Buster-report : wwPDB partial adaption of 1.1.7 (2018)
Percentile statistics : 20250101.v01 (using entries in the PDB archive January 1st 2025)
EM percentile statistics : 202505.v01 (Using data in the EMDB archive up until May 2025)
MapQ : 1.9.13
Ideal geometry (proteins) : Engh & Huber (2001)
Ideal geometry (DNA, RNA) : Parkinson et al. (1996)
Validation Pipeline (wwPDB-VP) : 2.49

1 Overall quality at a glance i

The following experimental techniques were used to determine the structure:
ELECTRON MICROSCOPY

The reported resolution of this entry is 3.48 Å.

Percentile scores (ranging between 0-100) for global validation metrics of the entry are shown in the following graphic. The table shows the number of entries on which the scores are based.

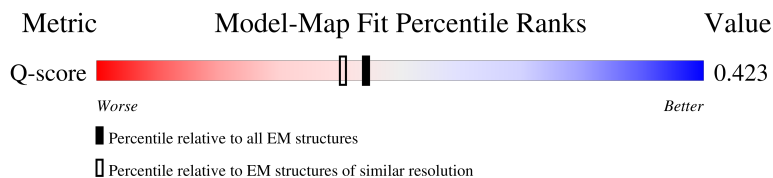
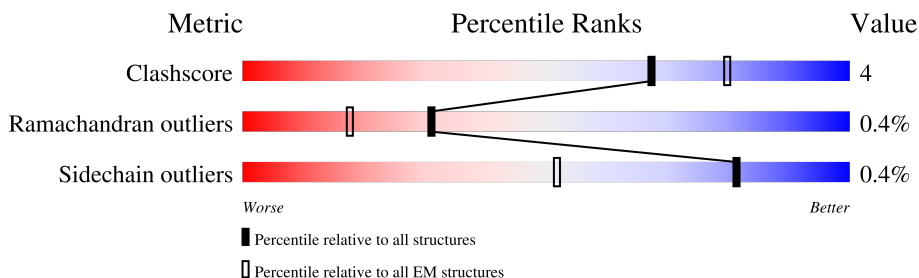

Metric	Whole archive (#Entries)	EM structures (#Entries)	Similar EM resolution (#Entries, resolution range(Å))
Clashscore	229148	23984	-
Ramachandran outliers	224038	23583	-
Sidechain outliers	223484	23102	-
Q-score	-	25397	13672 (2.98 - 3.98)

The table below summarises the geometric issues observed across the polymeric chains and their fit to the map. The red, orange, yellow and green segments of the bar indicate the fraction of residues that contain outliers for ≥ 3 , 2, 1 and 0 types of geometric quality criteria respectively. A grey segment represents the fraction of residues that are not modelled. The numeric value for each fraction is indicated below the corresponding segment, with a dot representing fractions $\leq 5\%$. The upper red bar (where present) indicates the fraction of residues that have poor fit to the EM map (all-atom inclusion $< 40\%$). The numeric value is given above the bar.

Mol	Chain	Length	Quality of chain
1	A	908	
1	B	908	
1	C	908	
1	D	908	

Continued on next page...

Continued from previous page...

Mol	Chain	Length	Quality of chain
2	E	525	
2	F	525	
3	G	2	
3	I	2	
3	J	2	
3	K	2	
3	M	2	
3	O	2	
3	R	2	
3	S	2	
3	U	2	
3	W	2	
4	H	5	
4	L	5	
4	Q	5	
4	T	5	
5	N	4	
5	V	4	
6	P	3	

2 Entry composition [i](#)

There are 8 unique types of molecules in this entry. The entry contains 33333 atoms, of which 0 are hydrogens and 0 are deuteriums.

In the tables below, the AltConf column contains the number of residues with at least one atom in alternate conformation and the Trace column contains the number of residues modelled with at most 2 atoms.

- Molecule 1 is a protein called Glutamate receptor ionotropic, kainate 2.

Mol	Chain	Residues	Atoms					AltConf	Trace
			Total	C	N	O	S		
1	A	840	6655	4266	1109	1240	40	0	0
1	B	818	6477	4157	1077	1207	36	0	0
1	C	841	6666	4272	1113	1241	40	0	0
1	D	818	6477	4157	1077	1207	36	0	0

There are 8 discrepancies between the modelled and reference sequences:

Chain	Residue	Modelled	Actual	Comment	Reference
A	567	VAL	ILE	conflict	UNP P42260
A	571	CYS	TYR	conflict	UNP P42260
B	567	VAL	ILE	conflict	UNP P42260
B	571	CYS	TYR	conflict	UNP P42260
C	567	VAL	ILE	conflict	UNP P42260
C	571	CYS	TYR	conflict	UNP P42260
D	567	VAL	ILE	conflict	UNP P42260
D	571	CYS	TYR	conflict	UNP P42260

- Molecule 2 is a protein called Neuropilin and tolloid-like protein 2.

Mol	Chain	Residues	Atoms					AltConf	Trace
			Total	C	N	O	S		
2	E	340	2700	1722	458	497	23	0	0
2	F	341	2705	1725	459	498	23	0	0

- Molecule 3 is an oligosaccharide called 2-acetamido-2-deoxy-beta-D-glucopyranose-(1-4)-2-acetamido-2-deoxy-beta-D-glucopyranose.



Mol	Chain	Residues	Atoms				AltConf	Trace
			Total	C	N	O		
3	G	2	28	16	2	10	0	0
3	I	2	28	16	2	10	0	0
3	J	2	28	16	2	10	0	0
3	K	2	28	16	2	10	0	0
3	M	2	28	16	2	10	0	0
3	O	2	28	16	2	10	0	0
3	R	2	28	16	2	10	0	0
3	S	2	28	16	2	10	0	0
3	U	2	28	16	2	10	0	0
3	W	2	28	16	2	10	0	0

- Molecule 4 is an oligosaccharide called alpha-D-mannopyranose-(1-3)-[alpha-D-mannopyranose-(1-6)]beta-D-mannopyranose-(1-4)-2-acetamido-2-deoxy-beta-D-glucopyranose-(1-4)-2-acetamido-2-deoxy-beta-D-glucopyranose.

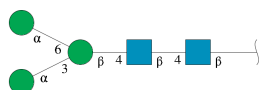

Mol	Chain	Residues	Atoms				AltConf	Trace
			Total	C	N	O		
4	H	5	61	34	2	25	0	0
4	L	5	61	34	2	25	0	0
4	Q	5	61	34	2	25	0	0
4	T	5	61	34	2	25	0	0

- Molecule 5 is an oligosaccharide called beta-D-mannopyranose-(1-3)-beta-D-mannopyranose-(1-4)-2-acetamido-2-deoxy-beta-D-glucopyranose-(1-4)-2-acetamido-2-deoxy-beta-D-glucopyranose.



Mol	Chain	Residues	Atoms				AltConf	Trace
			Total	C	N	O		
5	N	4	50	28	2	20	0	0
5	V	4	50	28	2	20	0	0

- Molecule 6 is an oligosaccharide called beta-D-mannopyranose-(1-4)-2-acetamido-2-deoxy-beta-D-glucopyranose-(1-4)-2-acetamido-2-deoxy-beta-D-glucopyranose.

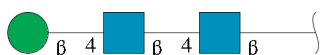

Mol	Chain	Residues	Atoms				AltConf	Trace
			Total	C	N	O		
6	P	3	39	22	2	15	0	0

- Molecule 7 is (2S)-3-(hexadecanoyloxy)-2-[(9Z)-octadec-9-enoyloxy]propyl 2-(trimethylamm onio)ethyl phosphate (CCD ID: POV) (formula: C₄₂H₈₂NO₈P).

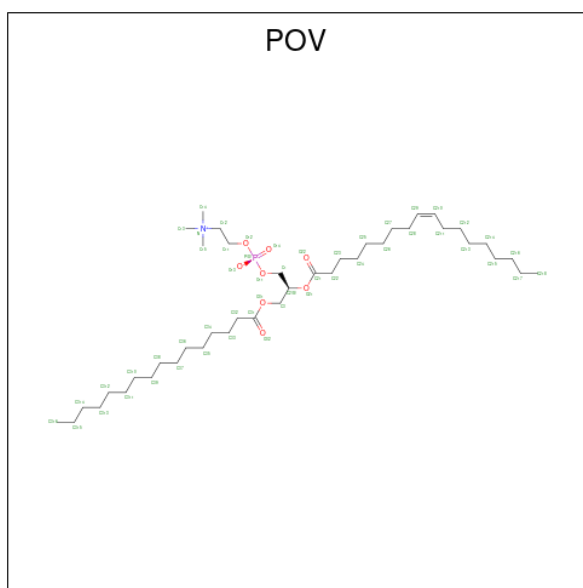

Mol	Chain	Residues	Atoms					AltConf
			Total	C	N	O	P	
7	A	1	52	42	1	8	1	0
7	A	1	52	42	1	8	1	0
7	A	1	52	42	1	8	1	0
7	A	1	52	42	1	8	1	0
7	B	1	52	42	1	8	1	0
7	B	1	52	42	1	8	1	0
7	C	1	52	42	1	8	1	0
7	C	1	52	42	1	8	1	0
7	C	1	52	42	1	8	1	0
7	C	1	52	42	1	8	1	0
7	D	1	52	42	1	8	1	0
7	D	1	52	42	1	8	1	0
7	D	1	52	42	1	8	1	0
7	D	1	52	42	1	8	1	0
7	F	1	52	42	1	8	1	0

- Molecule 8 is 2-acetamido-2-deoxy-beta-D-glucopyranose (CCD ID: NAG) (formula: $C_8H_{15}NO_6$).



Mol	Chain	Residues	Atoms				AltConf
			Total	C	N	O	
8	A	1	Total 14	C 8	N 1	O 5	0
8	A	1	Total 14	C 8	N 1	O 5	0
8	A	1	Total 14	C 8	N 1	O 5	0
8	A	1	Total 14	C 8	N 1	O 5	0
8	A	1	Total 14	C 8	N 1	O 5	0
8	B	1	Total 14	C 8	N 1	O 5	0
8	B	1	Total 14	C 8	N 1	O 5	0
8	C	1	Total 14	C 8	N 1	O 5	0
8	C	1	Total 14	C 8	N 1	O 5	0
8	C	1	Total 14	C 8	N 1	O 5	0
8	C	1	Total 14	C 8	N 1	O 5	0
8	D	1	Total 14	C 8	N 1	O 5	0
8	D	1	Total 14	C 8	N 1	O 5	0
8	E	1	Total 14	C 8	N 1	O 5	0

Continued on next page...

Continued from previous page...

Mol	Chain	Residues	Atoms				AltConf
			Total	C	N	O	
8	F	1	14	8	1	5	0

3 Residue-property plots [i](#)

These plots are drawn for all protein, RNA, DNA and oligosaccharide chains in the entry. The first graphic for a chain summarises the proportions of the various outlier classes displayed in the second graphic. The second graphic shows the sequence view annotated by issues in geometry and atom inclusion in map density. Residues are color-coded according to the number of geometric quality criteria for which they contain at least one outlier: green = 0, yellow = 1, orange = 2 and red = 3 or more. A red diamond above a residue indicates a poor fit to the EM map for this residue (all-atom inclusion < 40%). Stretches of 2 or more consecutive residues without any outlier are shown as a green connector. Residues present in the sample, but not in the model, are shown in grey.

- Molecule 1: Glutamate receptor ionotropic, kainate 2

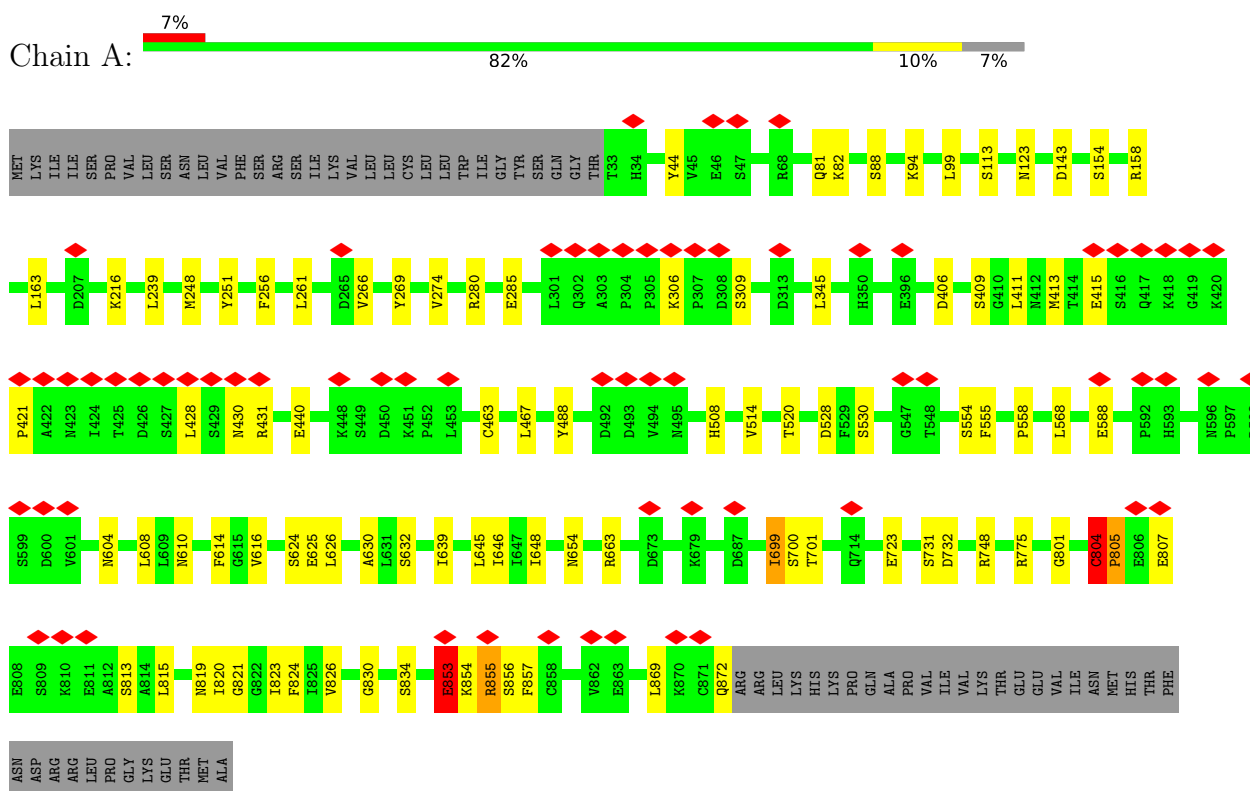

- Molecule 1: Glutamate receptor ionotropic, kainate 2

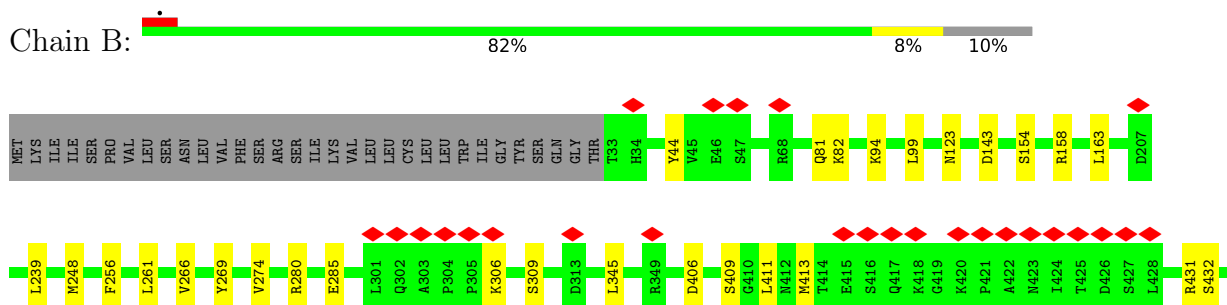

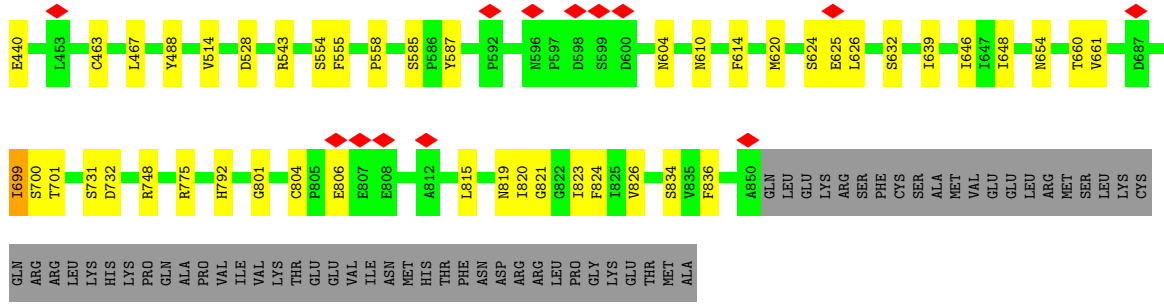

● Molecule 1: Glutamate receptor ionotropic, kainate 2

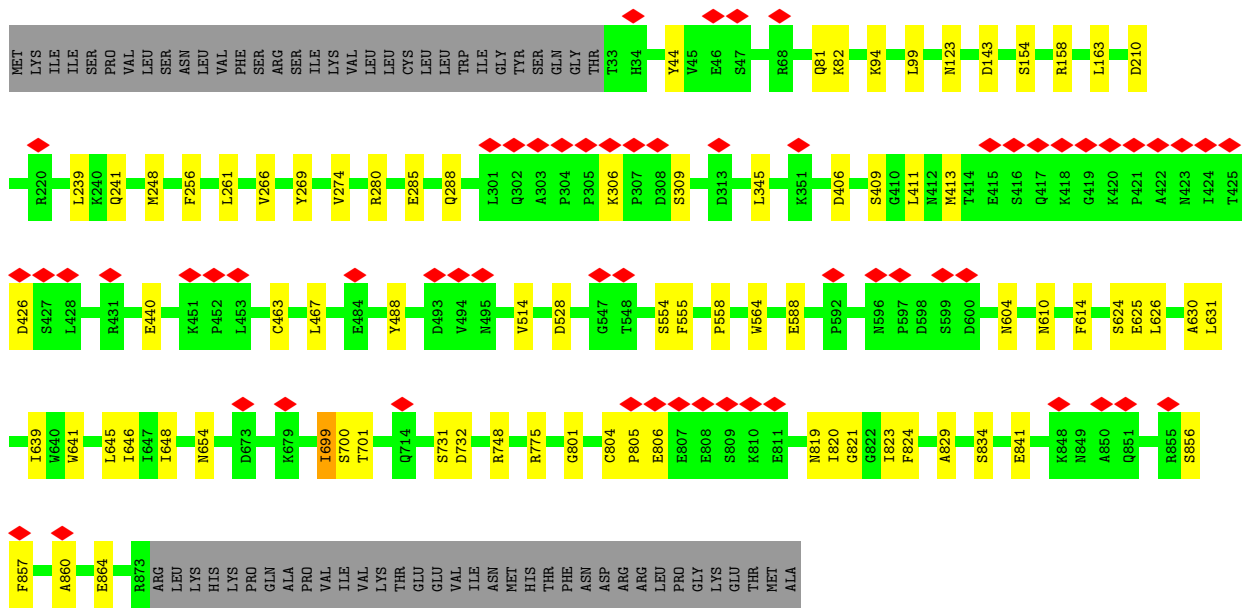
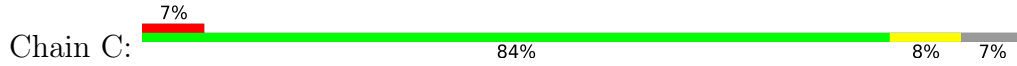

● Molecule 1: Glutamate receptor ionotropic, kainate 2

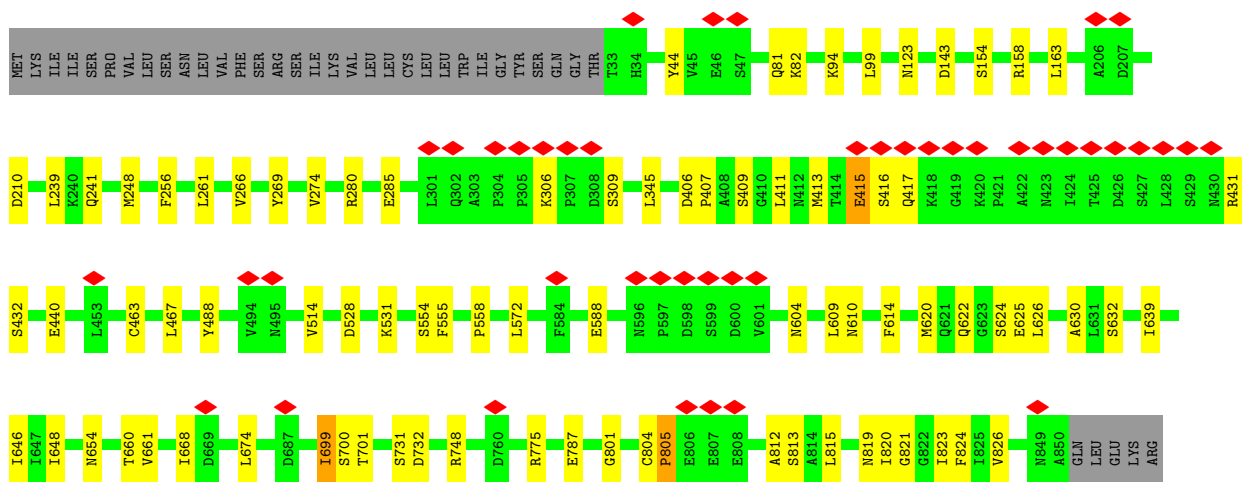
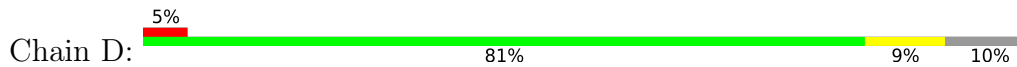

ARG VAL MET GLU ILE PRO CYS GLU TYR VAL ARG GLY ASP ASP SER ALA ALA SER ILE SER ILE ASP PHE

- Molecule 3: 2-acetamido-2-deoxy-beta-D-glucopyranose-(1-4)-2-acetamido-2-deoxy-beta-D-glucopyranose



MAG1
MAG2

- Molecule 3: 2-acetamido-2-deoxy-beta-D-glucopyranose-(1-4)-2-acetamido-2-deoxy-beta-D-glucopyranose



MAG1
MAG2

- Molecule 3: 2-acetamido-2-deoxy-beta-D-glucopyranose-(1-4)-2-acetamido-2-deoxy-beta-D-glucopyranose



MAG1
MAG2

- Molecule 3: 2-acetamido-2-deoxy-beta-D-glucopyranose-(1-4)-2-acetamido-2-deoxy-beta-D-glucopyranose



MAG1
MAG2

- Molecule 3: 2-acetamido-2-deoxy-beta-D-glucopyranose-(1-4)-2-acetamido-2-deoxy-beta-D-glucopyranose



MAG1
MAG2

- Molecule 3: 2-acetamido-2-deoxy-beta-D-glucopyranose-(1-4)-2-acetamido-2-deoxy-beta-D-glucopyranose





- Molecule 3: 2-acetamido-2-deoxy-beta-D-glucopyranose-(1-4)-2-acetamido-2-deoxy-beta-D-glucopyranose



- Molecule 3: 2-acetamido-2-deoxy-beta-D-glucopyranose-(1-4)-2-acetamido-2-deoxy-beta-D-glucopyranose



- Molecule 3: 2-acetamido-2-deoxy-beta-D-glucopyranose-(1-4)-2-acetamido-2-deoxy-beta-D-glucopyranose



- Molecule 3: 2-acetamido-2-deoxy-beta-D-glucopyranose-(1-4)-2-acetamido-2-deoxy-beta-D-glucopyranose



- Molecule 4: alpha-D-mannopyranose-(1-3)-[alpha-D-mannopyranose-(1-6)]beta-D-mannopyranose-(1-4)-2-acetamido-2-deoxy-beta-D-glucopyranose-(1-4)-2-acetamido-2-deoxy-beta-D-glucopyranose

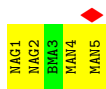

- Molecule 4: alpha-D-mannopyranose-(1-3)-[alpha-D-mannopyranose-(1-6)]beta-D-mannopyranose-(1-4)-2-acetamido-2-deoxy-beta-D-glucopyranose-(1-4)-2-acetamido-2-deoxy-beta-D-glucopyranose



- Molecule 4: alpha-D-mannopyranose-(1-3)-[alpha-D-mannopyranose-(1-6)]beta-D-mannopyranose-(1-4)-2-acetamido-2-deoxy-beta-D-glucopyranose-(1-4)-2-acetamido-2-deoxy-beta-D-glucopyranose

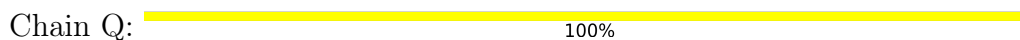

- Molecule 4: alpha-D-mannopyranose-(1-3)-[alpha-D-mannopyranose-(1-6)]beta-D-mannopyranose-(1-4)-2-acetamido-2-deoxy-beta-D-glucopyranose-(1-4)-2-acetamido-2-deoxy-beta-D-glucopyranose

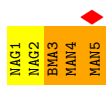

- Molecule 5: beta-D-mannopyranose-(1-3)-beta-D-mannopyranose-(1-4)-2-acetamido-2-deoxy-beta-D-glucopyranose-(1-4)-2-acetamido-2-deoxy-beta-D-glucopyranose

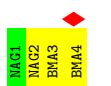

- Molecule 5: beta-D-mannopyranose-(1-3)-beta-D-mannopyranose-(1-4)-2-acetamido-2-deoxy-beta-D-glucopyranose-(1-4)-2-acetamido-2-deoxy-beta-D-glucopyranose

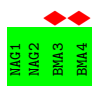

- Molecule 6: beta-D-mannopyranose-(1-4)-2-acetamido-2-deoxy-beta-D-glucopyranose-(1-4)-2-acetamido-2-deoxy-beta-D-glucopyranose

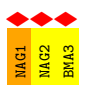

4 Experimental information

Property	Value	Source
EM reconstruction method	SINGLE PARTICLE	Depositor
Imposed symmetry	POINT, Not provided	
Number of particles used	112000	Depositor
Resolution determination method	FSC 0.143 CUT-OFF	Depositor
CTF correction method	NONE	Depositor
Microscope	TFS KRIOS	Depositor
Voltage (kV)	300	Depositor
Electron dose ($e^-/\text{\AA}^2$)	58.8	Depositor
Minimum defocus (nm)	1000	Depositor
Maximum defocus (nm)	2000	Depositor
Magnification	Not provided	
Image detector	GATAN K3 (6k x 4k)	Depositor
Maximum map value	41.433	Depositor
Minimum map value	-33.531	Depositor
Average map value	-0.029	Depositor
Map value standard deviation	1.097	Depositor
Recommended contour level	4.8	Depositor
Map size (\AA)	332.0, 332.0, 332.0	wwPDB
Map dimensions	400, 400, 400	wwPDB
Map angles ($^\circ$)	90.0, 90.0, 90.0	wwPDB
Pixel spacing (\AA)	0.83, 0.83, 0.83	Depositor

5 Model quality i

5.1 Standard geometry i

Bond lengths and bond angles in the following residue types are not validated in this section: POV, NAG, BMA, MAN

The Z score for a bond length (or angle) is the number of standard deviations the observed value is removed from the expected value. A bond length (or angle) with $|Z| > 5$ is considered an outlier worth inspection. RMSZ is the root-mean-square of all Z scores of the bond lengths (or angles).

Mol	Chain	Bond lengths		Bond angles	
		RMSZ	# Z >5	RMSZ	# Z >5
1	A	0.27	0/6805	0.69	7/9212 (0.1%)
1	B	0.27	0/6626	0.65	0/8976
1	C	0.26	0/6816	0.65	0/9226
1	D	0.26	0/6626	0.65	4/8976 (0.0%)
2	E	0.29	0/2767	0.87	6/3741 (0.2%)
2	F	0.32	0/2772	0.87	5/3748 (0.1%)
All	All	0.27	0/32412	0.70	22/43879 (0.1%)

Chiral center outliers are detected by calculating the chiral volume of a chiral center and verifying if the center is modelled as a planar moiety or with the opposite hand. A planarity outlier is detected by checking planarity of atoms in a peptide group, atoms in a mainchain group or atoms of a sidechain that are expected to be planar.

Mol	Chain	#Chirality outliers	#Planarity outliers
1	A	0	7
1	B	0	3
1	C	0	4
1	D	0	5
2	E	0	5
2	F	0	5
All	All	0	29

There are no bond length outliers.

The worst 5 of 22 bond angle outliers are listed below:

Mol	Chain	Res	Type	Atoms	Z	Observed(°)	Ideal(°)
1	A	804	CYS	O-C-N	-11.37	108.24	121.32
2	F	295	PRO	CA-C-N	-8.71	108.95	119.84
2	F	295	PRO	C-N-CA	-8.71	108.95	119.84
2	E	295	PRO	CA-C-N	-8.68	109.00	119.84

Continued on next page...

Continued from previous page...

Mol	Chain	Res	Type	Atoms	Z	Observed(°)	Ideal(°)
2	E	295	PRO	C-N-CA	-8.68	109.00	119.84

There are no chirality outliers.

5 of 29 planarity outliers are listed below:

Mol	Chain	Res	Type	Group
1	A	415	GLU	Peptide
1	A	431	ARG	Peptide
1	A	699	ILE	Peptide
1	A	804	CYS	Mainchain,Peptide
1	A	853	GLU	Peptide

5.2 Too-close contacts [i](#)

In the following table, the Non-H and H(model) columns list the number of non-hydrogen atoms and hydrogen atoms in the chain respectively. The H(added) column lists the number of hydrogen atoms added and optimized by MolProbity. The Clashes column lists the number of clashes within the asymmetric unit, whereas Symm-Clashes lists symmetry-related clashes.

Mol	Chain	Non-H	H(model)	H(added)	Clashes	Symm-Clashes
1	A	6655	0	6626	53	0
1	B	6477	0	6442	43	0
1	C	6666	0	6641	46	0
1	D	6477	0	6443	46	0
2	E	2700	0	2648	31	0
2	F	2705	0	2653	34	0
3	G	28	0	25	0	0
3	I	28	0	25	0	0
3	J	28	0	25	0	0
3	K	28	0	25	0	0
3	M	28	0	25	0	0
3	O	28	0	25	1	0
3	R	28	0	25	0	0
3	S	28	0	25	0	0
3	U	28	0	25	0	0
3	W	28	0	25	0	0
4	H	61	0	52	0	0
4	L	61	0	52	0	0
4	Q	61	0	52	0	0
4	T	61	0	52	3	0
5	N	50	0	43	0	0

Continued on next page...

Continued from previous page...

Mol	Chain	Non-H	H(model)	H(added)	Clashes	Symm-Clashes
5	V	50	0	43	0	0
6	P	39	0	34	1	0
7	A	208	0	328	5	0
7	B	104	0	164	3	0
7	C	208	0	328	13	0
7	D	208	0	328	11	0
7	F	52	0	82	1	0
8	A	70	0	65	1	0
8	B	28	0	26	0	0
8	C	56	0	52	0	0
8	D	28	0	26	0	0
8	E	14	0	13	0	0
8	F	14	0	13	0	0
All	All	33333	0	33456	254	0

The all-atom clashscore is defined as the number of clashes found per 1000 atoms (including hydrogen atoms). The all-atom clashscore for this structure is 4.

The worst 5 of 254 close contacts within the same asymmetric unit are listed below, sorted by their clash magnitude.

Atom-1	Atom-2	Interatomic distance (Å)	Clash overlap (Å)
1:A:823:ILE:HD12	1:D:646:ILE:HB	1.76	0.66
1:C:748:ARG:HE	1:C:801:GLY:HA2	1.64	0.63
1:A:748:ARG:HE	1:A:801:GLY:HA2	1.64	0.62
1:C:639:ILE:HD11	7:D:1003:POV:H37A	1.80	0.62
1:B:748:ARG:HE	1:B:801:GLY:HA2	1.64	0.62

There are no symmetry-related clashes.

5.3 Torsion angles [i](#)

5.3.1 Protein backbone [i](#)

In the following table, the Percentiles column shows the percent Ramachandran outliers of the chain as a percentile score with respect to all PDB entries followed by that with respect to all EM entries.

The Analysed column shows the number of residues for which the backbone conformation was analysed, and the total number of residues.

Mol	Chain	Analysed	Favoured	Allowed	Outliers	Percentiles	
1	A	838/908 (92%)	765 (91%)	68 (8%)	5 (1%)	21	53
1	B	816/908 (90%)	751 (92%)	64 (8%)	1 (0%)	48	79
1	C	839/908 (92%)	774 (92%)	64 (8%)	1 (0%)	48	79
1	D	816/908 (90%)	756 (93%)	56 (7%)	4 (0%)	24	58
2	E	338/525 (64%)	271 (80%)	66 (20%)	1 (0%)	36	67
2	F	339/525 (65%)	272 (80%)	63 (19%)	4 (1%)	10	41
All	All	3986/4682 (85%)	3589 (90%)	381 (10%)	16 (0%)	31	62

5 of 16 Ramachandran outliers are listed below:

Mol	Chain	Res	Type
1	A	804	CYS
2	F	175	PRO
1	D	417	GLN
1	A	855	ARG
1	D	416	SER

5.3.2 Protein sidechains [i](#)

In the following table, the Percentiles column shows the percent sidechain outliers of the chain as a percentile score with respect to all PDB entries followed by that with respect to all EM entries.

The Analysed column shows the number of residues for which the sidechain conformation was analysed, and the total number of residues.

Mol	Chain	Analysed	Rotameric	Outliers	Percentiles	
1	A	731/794 (92%)	728 (100%)	3 (0%)	84	81
1	B	710/794 (89%)	708 (100%)	2 (0%)	86	83
1	C	732/794 (92%)	730 (100%)	2 (0%)	86	83
1	D	710/794 (89%)	708 (100%)	2 (0%)	86	83
2	E	300/465 (64%)	298 (99%)	2 (1%)	76	77
2	F	300/465 (64%)	296 (99%)	4 (1%)	61	72
All	All	3483/4106 (85%)	3468 (100%)	15 (0%)	81	81

5 of 15 residues with a non-rotameric sidechain are listed below:

Mol	Chain	Res	Type
1	D	604	ASN

Continued on next page...

Continued from previous page...

Mol	Chain	Res	Type
2	F	173	PRO
1	D	648	ILE
2	F	282	LEU
2	F	147	LEU

Sometimes sidechains can be flipped to improve hydrogen bonding and reduce clashes. 5 of 52 such sidechains are listed below:

Mol	Chain	Res	Type
1	C	499	ASN
1	D	141	ASN
2	F	329	ASN
1	C	549	ASN
1	C	819	ASN

5.3.3 RNA [i](#)

There are no RNA molecules in this entry.

5.4 Non-standard residues in protein, DNA, RNA chains [i](#)

There are no non-standard protein/DNA/RNA residues in this entry.

5.5 Carbohydrates [i](#)

51 monosaccharides are modelled in this entry.

In the following table, the Counts columns list the number of bonds (or angles) for which Mogul statistics could be retrieved, the number of bonds (or angles) that are observed in the model and the number of bonds (or angles) that are defined in the Chemical Component Dictionary. The Link column lists molecule types, if any, to which the group is linked. The Z score for a bond length (or angle) is the number of standard deviations the observed value is removed from the expected value. A bond length (or angle) with $|Z| > 2$ is considered an outlier worth inspection. RMSZ is the root-mean-square of all Z scores of the bond lengths (or angles).

Mol	Type	Chain	Res	Link	Bond lengths			Bond angles		
					Counts	RMSZ	# Z > 2	Counts	RMSZ	# Z > 2
3	NAG	G	1	3,1	14,14,15	0.91	1 (7%)	17,19,21	1.07	1 (5%)
3	NAG	G	2	3	14,14,15	0.43	0	17,19,21	0.73	1 (5%)
4	NAG	H	1	4,1	14,14,15	1.37	2 (14%)	17,19,21	1.34	2 (11%)
4	NAG	H	2	4	14,14,15	1.42	1 (7%)	17,19,21	1.58	1 (5%)

Mol	Type	Chain	Res	Link	Bond lengths			Bond angles		
					Counts	RMSZ	# Z > 2	Counts	RMSZ	# Z > 2
4	BMA	H	3	4	11,11,12	0.72	0	15,15,17	0.75	0
4	MAN	H	4	4	11,11,12	1.02	0	15,15,17	1.17	1 (6%)
4	MAN	H	5	4	11,11,12	1.64	3 (27%)	15,15,17	1.71	2 (13%)
3	NAG	I	1	3,1	14,14,15	1.06	1 (7%)	17,19,21	1.38	1 (5%)
3	NAG	I	2	3	14,14,15	0.34	0	17,19,21	0.54	0
3	NAG	J	1	3,1	14,14,15	0.48	0	17,19,21	0.44	0
3	NAG	J	2	3	14,14,15	0.48	0	17,19,21	0.47	0
3	NAG	K	1	3,1	14,14,15	0.79	1 (7%)	17,19,21	1.57	2 (11%)
3	NAG	K	2	3	14,14,15	0.53	0	17,19,21	0.39	0
4	NAG	L	1	4,1	14,14,15	1.26	2 (14%)	17,19,21	1.71	2 (11%)
4	NAG	L	2	4	14,14,15	0.79	1 (7%)	17,19,21	0.82	1 (5%)
4	BMA	L	3	4	11,11,12	0.89	1 (9%)	15,15,17	0.88	1 (6%)
4	MAN	L	4	4	11,11,12	1.76	3 (27%)	15,15,17	1.55	2 (13%)
4	MAN	L	5	4	11,11,12	1.56	3 (27%)	15,15,17	1.72	2 (13%)
3	NAG	M	1	3,1	14,14,15	1.25	1 (7%)	17,19,21	1.30	3 (17%)
3	NAG	M	2	3	14,14,15	0.83	1 (7%)	17,19,21	0.37	0
5	NAG	N	1	5,1	14,14,15	0.29	0	17,19,21	0.59	0
5	NAG	N	2	5	14,14,15	0.39	0	17,19,21	0.95	1 (5%)
5	BMA	N	3	5	11,11,12	1.32	3 (27%)	15,15,17	1.09	1 (6%)
5	BMA	N	4	5	11,11,12	0.74	0	15,15,17	1.09	1 (6%)
3	NAG	O	1	3,1	14,14,15	0.26	0	17,19,21	0.80	1 (5%)
3	NAG	O	2	3	14,14,15	0.81	1 (7%)	17,19,21	0.57	0
6	NAG	P	1	6,1	14,14,15	0.37	0	17,19,21	0.94	1 (5%)
6	NAG	P	2	6	14,14,15	0.52	0	17,19,21	1.10	2 (11%)
6	BMA	P	3	6	11,11,12	1.32	2 (18%)	15,15,17	1.45	3 (20%)
4	NAG	Q	1	4,1	14,14,15	0.83	2 (14%)	17,19,21	1.25	2 (11%)
4	NAG	Q	2	4	14,14,15	0.69	1 (7%)	17,19,21	0.64	0
4	BMA	Q	3	4	11,11,12	1.45	2 (18%)	15,15,17	1.59	3 (20%)
4	MAN	Q	4	4	11,11,12	1.39	3 (27%)	15,15,17	1.66	2 (13%)
4	MAN	Q	5	4	11,11,12	1.01	0	15,15,17	1.17	2 (13%)
3	NAG	R	1	3,1	14,14,15	1.27	2 (14%)	17,19,21	1.17	2 (11%)
3	NAG	R	2	3	14,14,15	0.59	0	17,19,21	0.55	0
3	NAG	S	1	3,1	14,14,15	0.88	1 (7%)	17,19,21	0.95	0
3	NAG	S	2	3	14,14,15	0.35	0	17,19,21	0.43	0
4	NAG	T	1	4,1	14,14,15	1.21	2 (14%)	17,19,21	1.74	2 (11%)
4	NAG	T	2	4	14,14,15	1.42	2 (14%)	17,19,21	1.61	1 (5%)

Mol	Type	Chain	Res	Link	Bond lengths			Bond angles		
					Counts	RMSZ	# Z > 2	Counts	RMSZ	# Z > 2
4	BMA	T	3	4	11,11,12	0.97	1 (9%)	15,15,17	0.92	1 (6%)
4	MAN	T	4	4	11,11,12	1.05	2 (18%)	15,15,17	1.75	2 (13%)
4	MAN	T	5	4	11,11,12	1.20	1 (9%)	15,15,17	1.16	1 (6%)
3	NAG	U	1	3,1	14,14,15	0.26	0	17,19,21	0.53	0
3	NAG	U	2	3	14,14,15	0.38	0	17,19,21	0.49	0
5	NAG	V	1	5,1	14,14,15	0.21	0	17,19,21	0.55	0
5	NAG	V	2	5	14,14,15	0.31	0	17,19,21	0.43	0
5	BMA	V	3	5	11,11,12	1.01	0	15,15,17	0.90	0
5	BMA	V	4	5	11,11,12	0.85	0	15,15,17	0.73	0
3	NAG	W	1	3,1	14,14,15	0.55	0	17,19,21	0.62	0
3	NAG	W	2	3	14,14,15	0.51	0	17,19,21	0.63	1 (5%)

In the following table, the Chirals column lists the number of chiral outliers, the number of chiral centers analysed, the number of these observed in the model and the number defined in the Chemical Component Dictionary. Similar counts are reported in the Torsion and Rings columns. '-' means no outliers of that kind were identified.

Mol	Type	Chain	Res	Link	Chirals	Torsions	Rings
3	NAG	G	1	3,1	-	3/6/23/26	0/1/1/1
3	NAG	G	2	3	-	2/6/23/26	0/1/1/1
4	NAG	H	1	4,1	-	4/6/23/26	0/1/1/1
4	NAG	H	2	4	-	2/6/23/26	0/1/1/1
4	BMA	H	3	4	-	2/2/19/22	0/1/1/1
4	MAN	H	4	4	-	1/2/19/22	1/1/1/1
4	MAN	H	5	4	-	0/2/19/22	0/1/1/1
3	NAG	I	1	3,1	-	3/6/23/26	0/1/1/1
3	NAG	I	2	3	-	2/6/23/26	0/1/1/1
3	NAG	J	1	3,1	-	0/6/23/26	0/1/1/1
3	NAG	J	2	3	-	1/6/23/26	0/1/1/1
3	NAG	K	1	3,1	-	2/6/23/26	0/1/1/1
3	NAG	K	2	3	-	0/6/23/26	0/1/1/1
4	NAG	L	1	4,1	-	3/6/23/26	0/1/1/1
4	NAG	L	2	4	-	2/6/23/26	0/1/1/1
4	BMA	L	3	4	-	0/2/19/22	0/1/1/1
4	MAN	L	4	4	-	1/2/19/22	1/1/1/1
4	MAN	L	5	4	-	2/2/19/22	0/1/1/1
3	NAG	M	1	3,1	-	2/6/23/26	0/1/1/1
3	NAG	M	2	3	-	2/6/23/26	0/1/1/1
5	NAG	N	1	5,1	-	2/6/23/26	0/1/1/1

Continued on next page...

Continued from previous page...

Mol	Type	Chain	Res	Link	Chirals	Torsions	Rings
5	NAG	N	2	5	-	4/6/23/26	0/1/1/1
5	BMA	N	3	5	-	1/2/19/22	0/1/1/1
5	BMA	N	4	5	-	0/2/19/22	0/1/1/1
3	NAG	O	1	3,1	-	2/6/23/26	0/1/1/1
3	NAG	O	2	3	-	4/6/23/26	0/1/1/1
6	NAG	P	1	6,1	-	0/6/23/26	0/1/1/1
6	NAG	P	2	6	-	2/6/23/26	0/1/1/1
6	BMA	P	3	6	-	0/2/19/22	0/1/1/1
4	NAG	Q	1	4,1	-	4/6/23/26	0/1/1/1
4	NAG	Q	2	4	-	1/6/23/26	0/1/1/1
4	BMA	Q	3	4	-	2/2/19/22	0/1/1/1
4	MAN	Q	4	4	-	2/2/19/22	1/1/1/1
4	MAN	Q	5	4	-	1/2/19/22	1/1/1/1
3	NAG	R	1	3,1	-	1/6/23/26	0/1/1/1
3	NAG	R	2	3	-	4/6/23/26	0/1/1/1
3	NAG	S	1	3,1	-	0/6/23/26	0/1/1/1
3	NAG	S	2	3	-	0/6/23/26	0/1/1/1
4	NAG	T	1	4,1	-	3/6/23/26	0/1/1/1
4	NAG	T	2	4	-	2/6/23/26	0/1/1/1
4	BMA	T	3	4	-	2/2/19/22	0/1/1/1
4	MAN	T	4	4	-	2/2/19/22	1/1/1/1
4	MAN	T	5	4	-	1/2/19/22	1/1/1/1
3	NAG	U	1	3,1	-	1/6/23/26	0/1/1/1
3	NAG	U	2	3	-	2/6/23/26	0/1/1/1
5	NAG	V	1	5,1	-	1/6/23/26	0/1/1/1
5	NAG	V	2	5	-	2/6/23/26	0/1/1/1
5	BMA	V	3	5	-	2/2/19/22	0/1/1/1
5	BMA	V	4	5	-	0/2/19/22	0/1/1/1
3	NAG	W	1	3,1	-	1/6/23/26	0/1/1/1
3	NAG	W	2	3	-	0/6/23/26	0/1/1/1

The worst 5 of 46 bond length outliers are listed below:

Mol	Chain	Res	Type	Atoms	Z	Observed(Å)	Ideal(Å)
4	H	2	NAG	O5-C1	4.93	1.52	1.43
4	T	2	NAG	O5-C1	4.78	1.51	1.43
3	M	1	NAG	C1-C2	4.14	1.58	1.52
4	L	1	NAG	O5-C1	3.96	1.50	1.43
4	H	1	NAG	O5-C1	-3.96	1.37	1.43

The worst 5 of 51 bond angle outliers are listed below:

Mol	Chain	Res	Type	Atoms	Z	Observed(°)	Ideal(°)
4	T	2	NAG	C1-O5-C5	6.36	120.71	112.19
4	H	2	NAG	C1-O5-C5	6.26	120.57	112.19
4	T	1	NAG	C1-O5-C5	6.00	120.23	112.19
4	L	1	NAG	C1-O5-C5	5.85	120.03	112.19
4	T	4	MAN	C1-O5-C5	5.81	119.98	112.19

There are no chirality outliers.

5 of 83 torsion outliers are listed below:

Mol	Chain	Res	Type	Atoms
5	V	2	NAG	O5-C5-C6-O6
4	H	3	BMA	O5-C5-C6-O6
5	N	1	NAG	C4-C5-C6-O6
4	T	4	MAN	O5-C5-C6-O6
4	H	3	BMA	C4-C5-C6-O6

5 of 6 ring outliers are listed below:

Mol	Chain	Res	Type	Atoms
4	T	4	MAN	C1-C2-C3-C4-C5-O5
4	L	4	MAN	C1-C2-C3-C4-C5-O5
4	T	5	MAN	C1-C2-C3-C4-C5-O5
4	Q	4	MAN	C1-C2-C3-C4-C5-O5
4	H	4	MAN	C1-C2-C3-C4-C5-O5

5 monomers are involved in 5 short contacts:

Mol	Chain	Res	Type	Clashes	Symm-Clashes
4	T	4	MAN	2	0
4	T	3	BMA	2	0
6	P	1	NAG	1	0
4	T	5	MAN	1	0
3	O	1	NAG	1	0

The following is a two-dimensional graphical depiction of Mogul quality analysis of bond lengths, bond angles, torsion angles, and ring geometry for oligosaccharide.

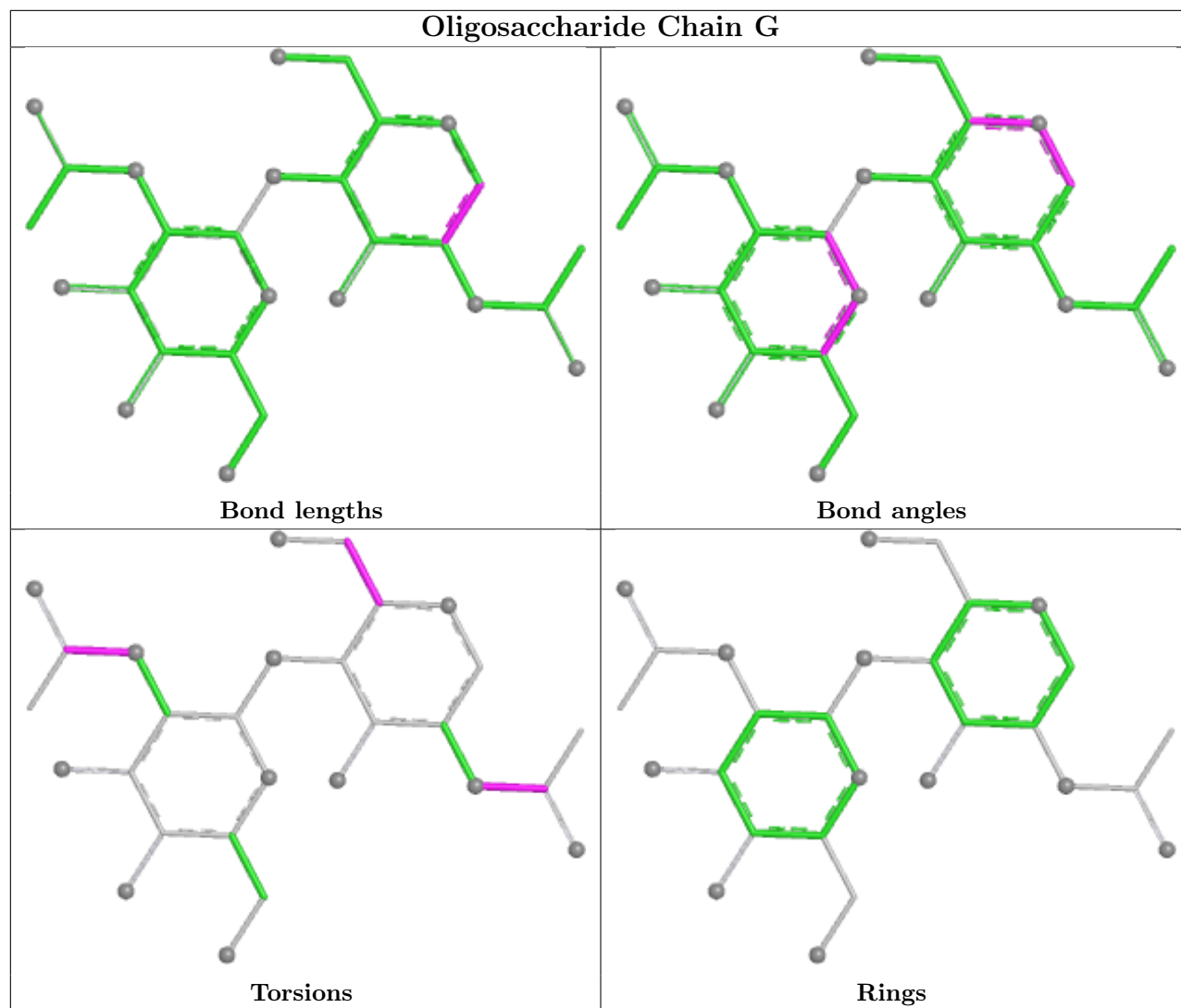

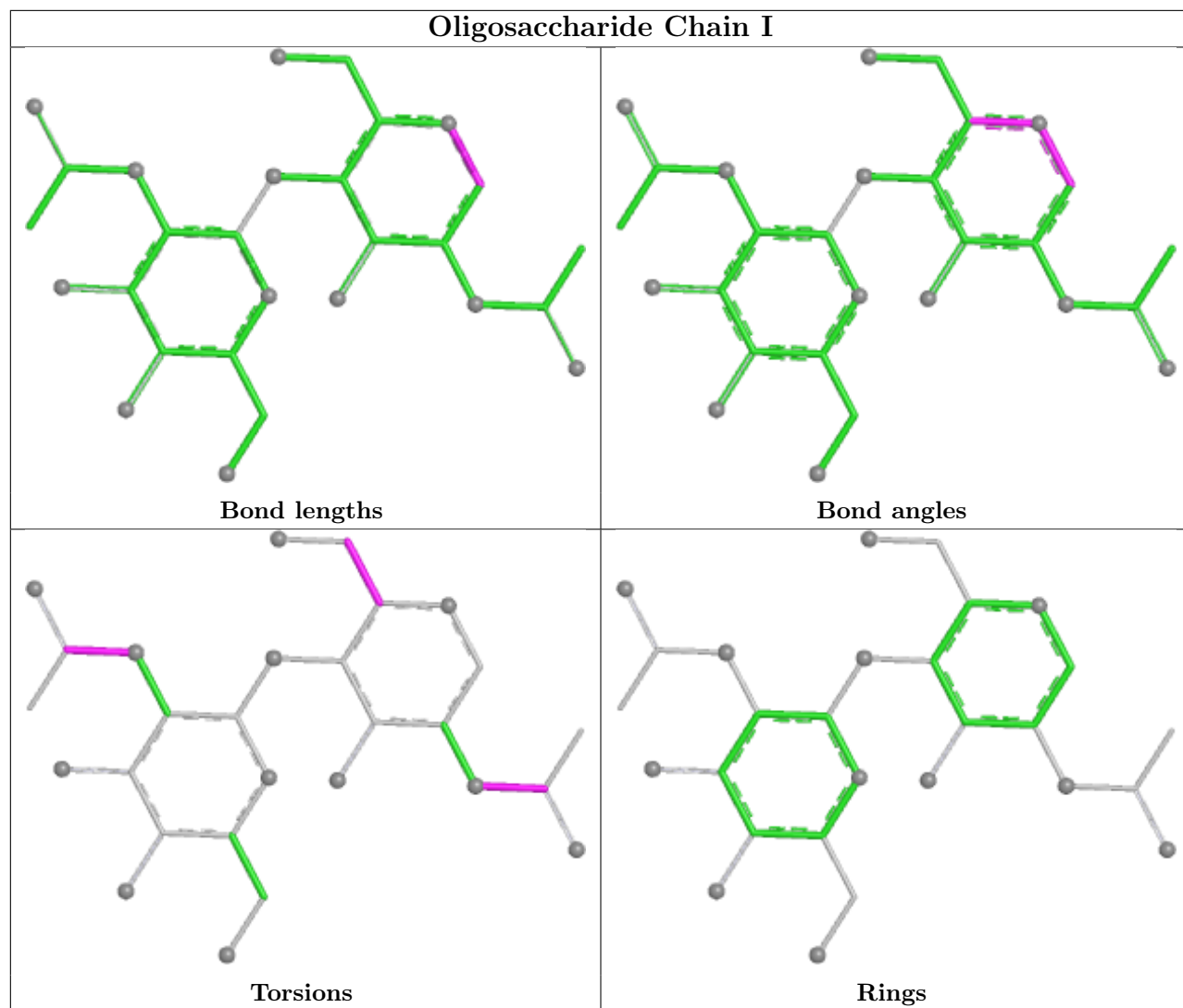

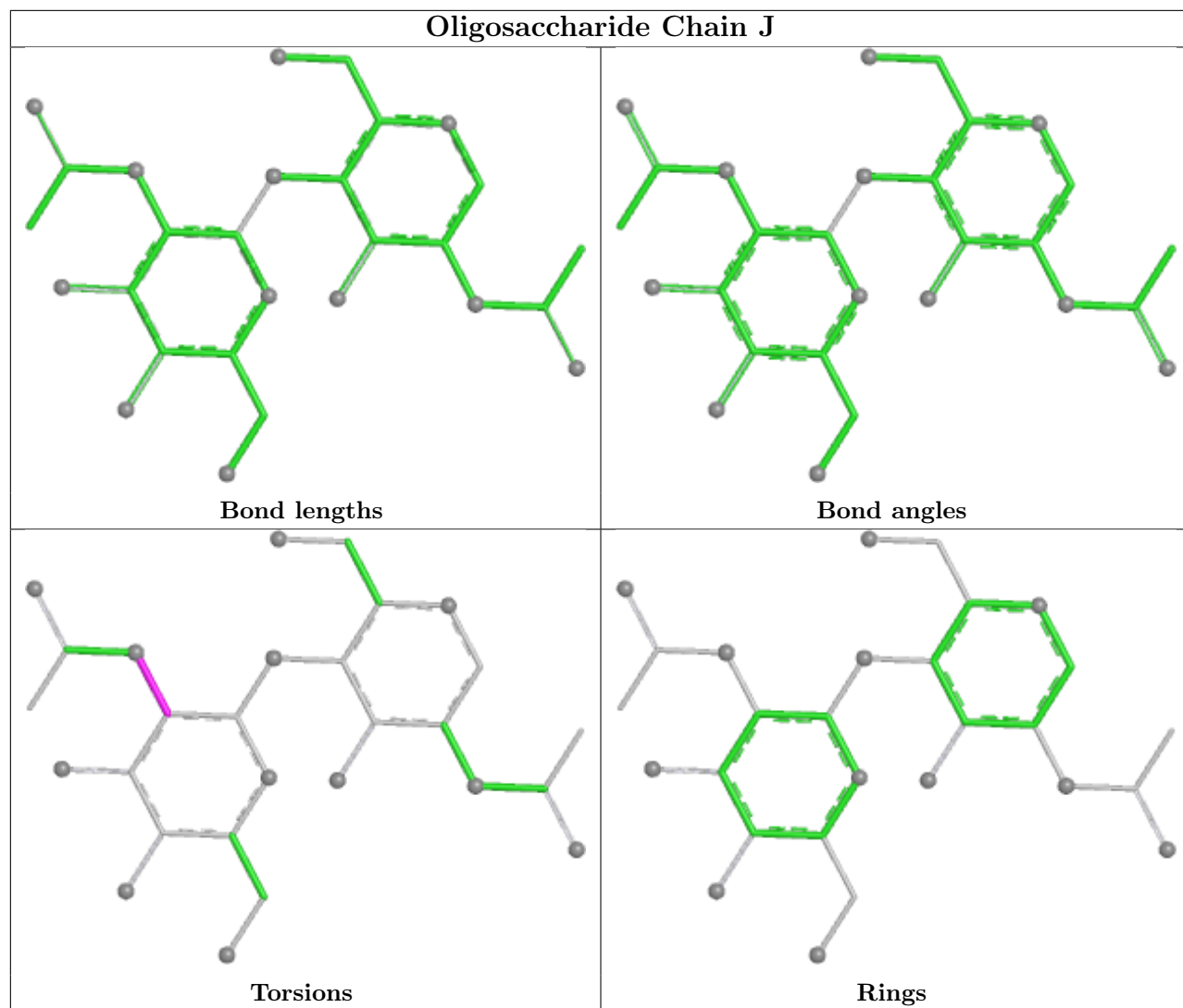

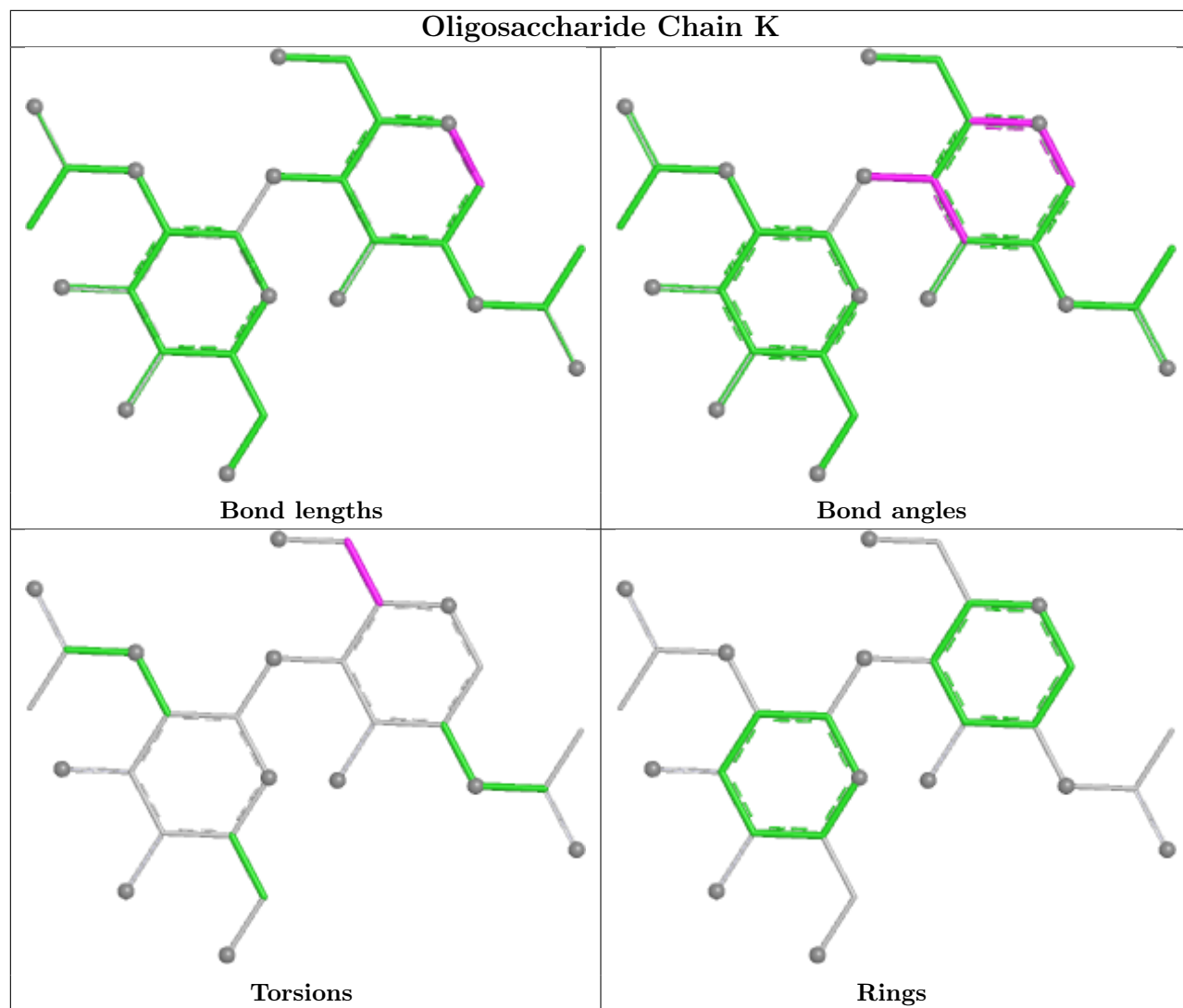

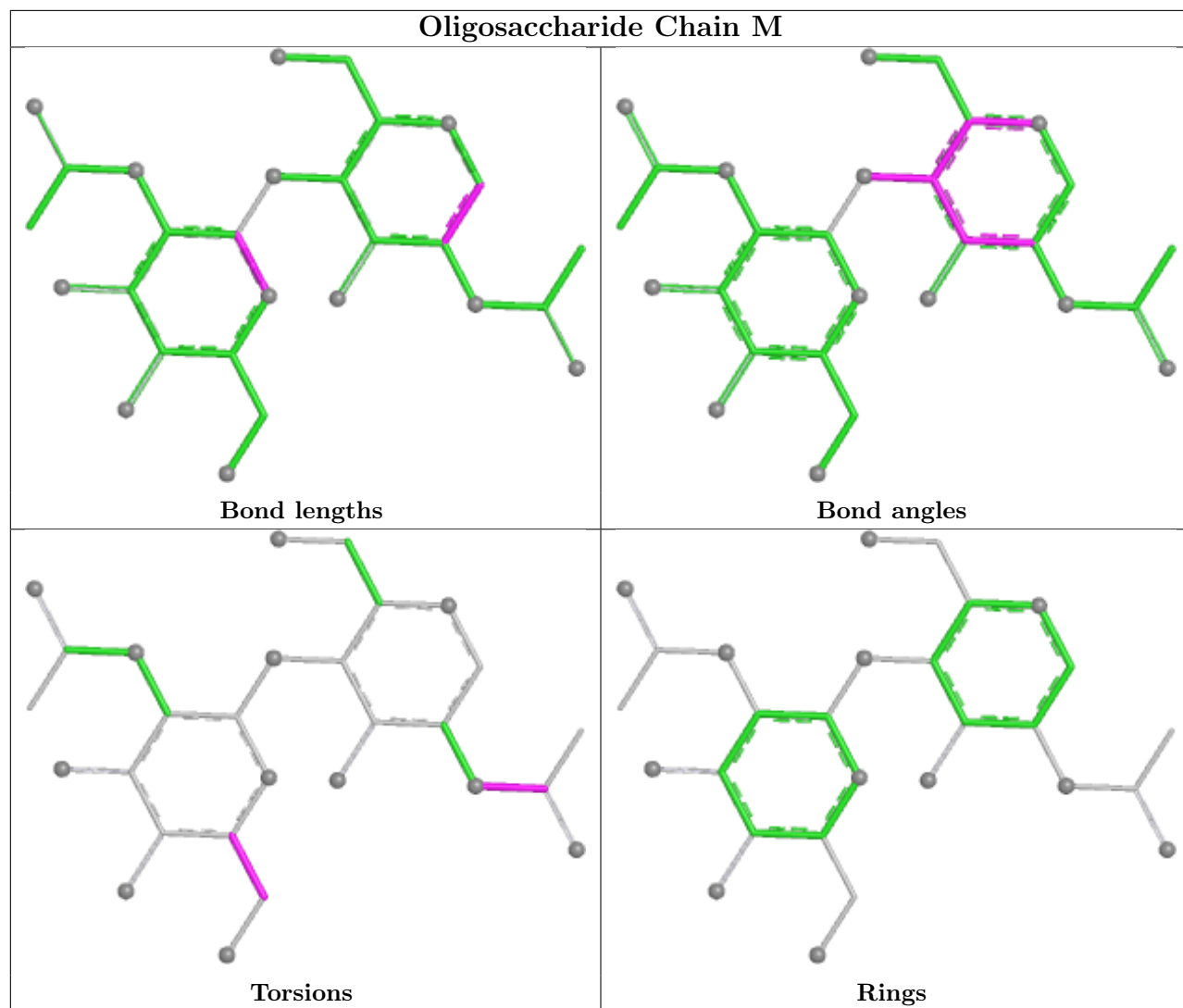

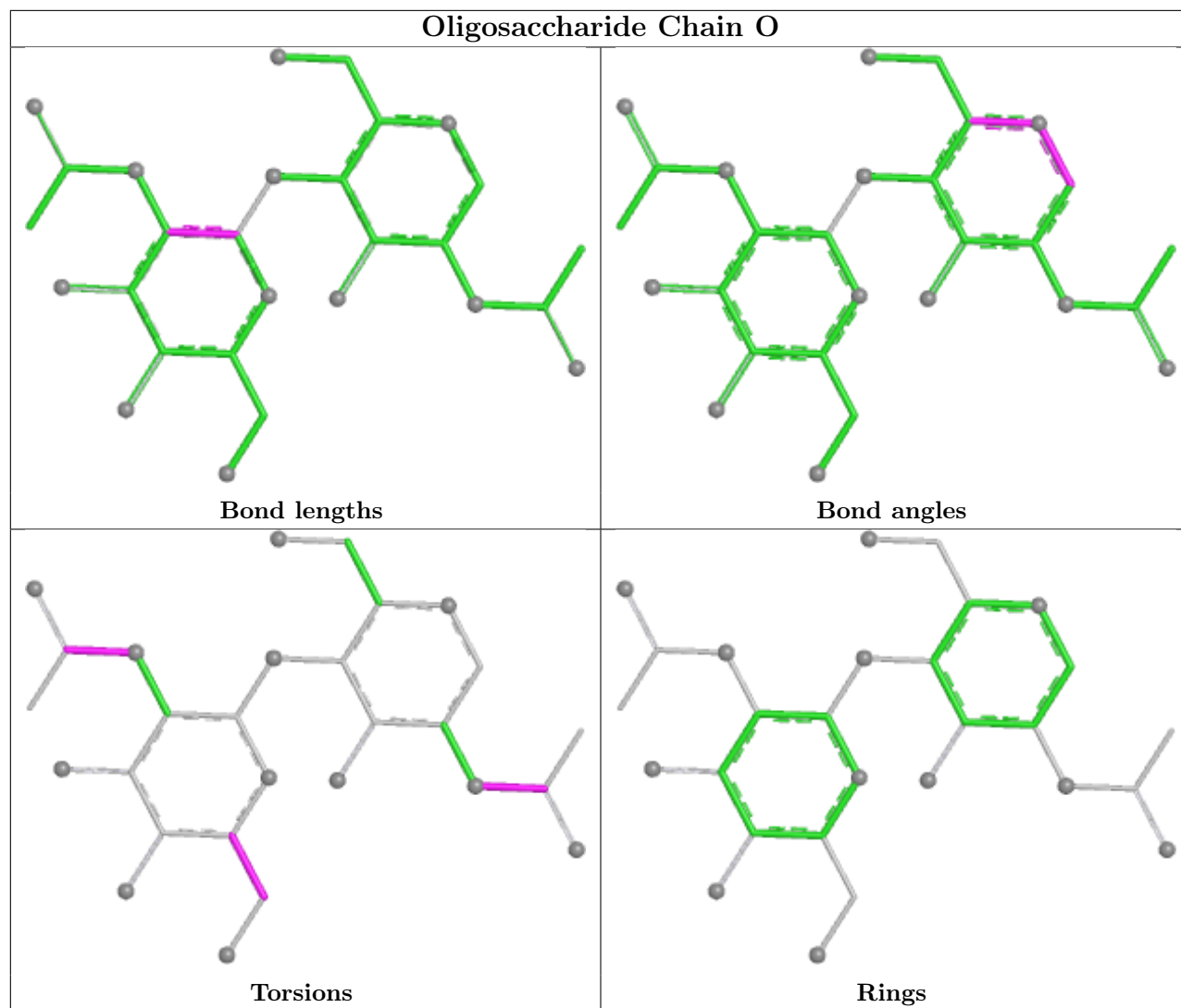

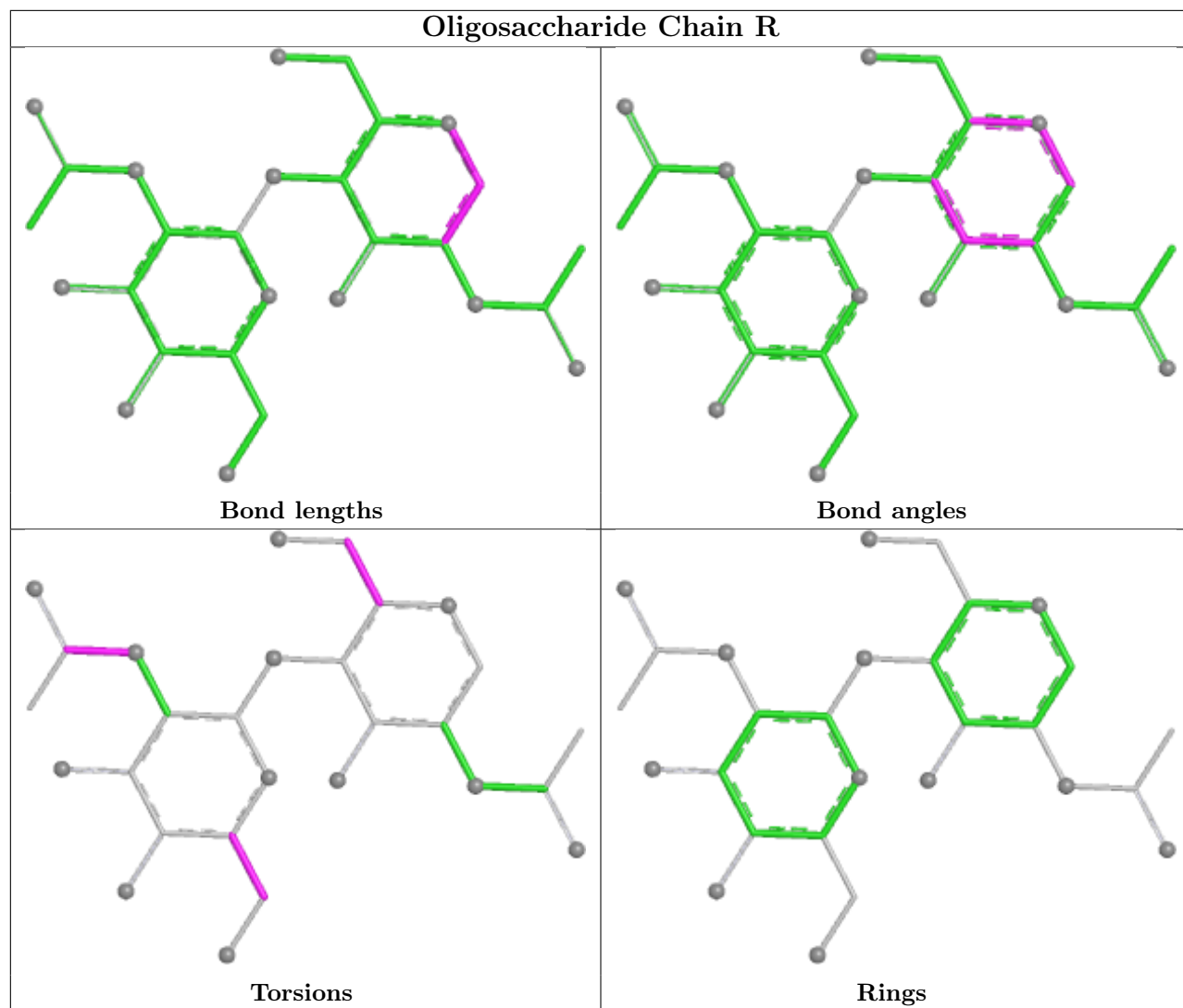

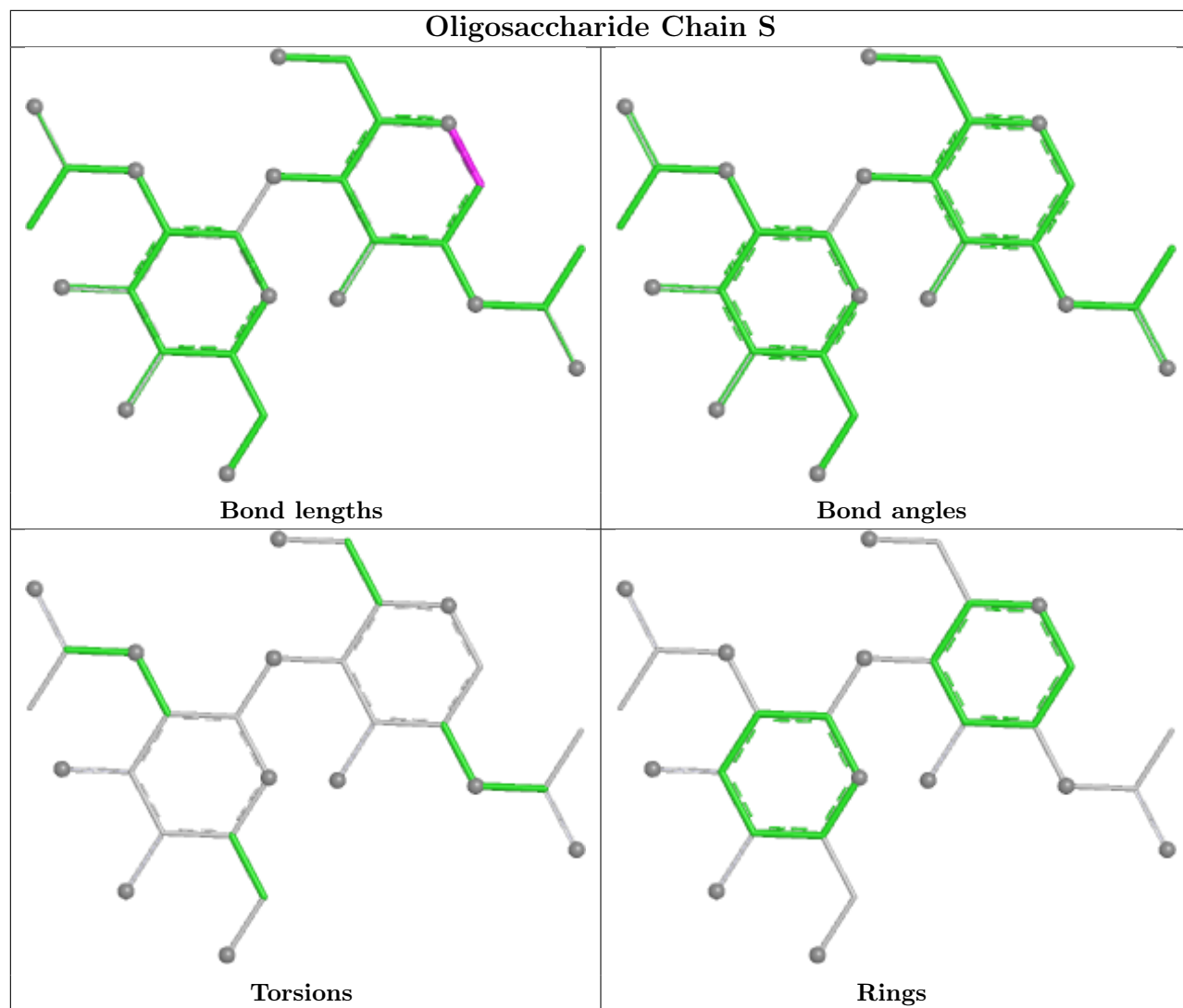

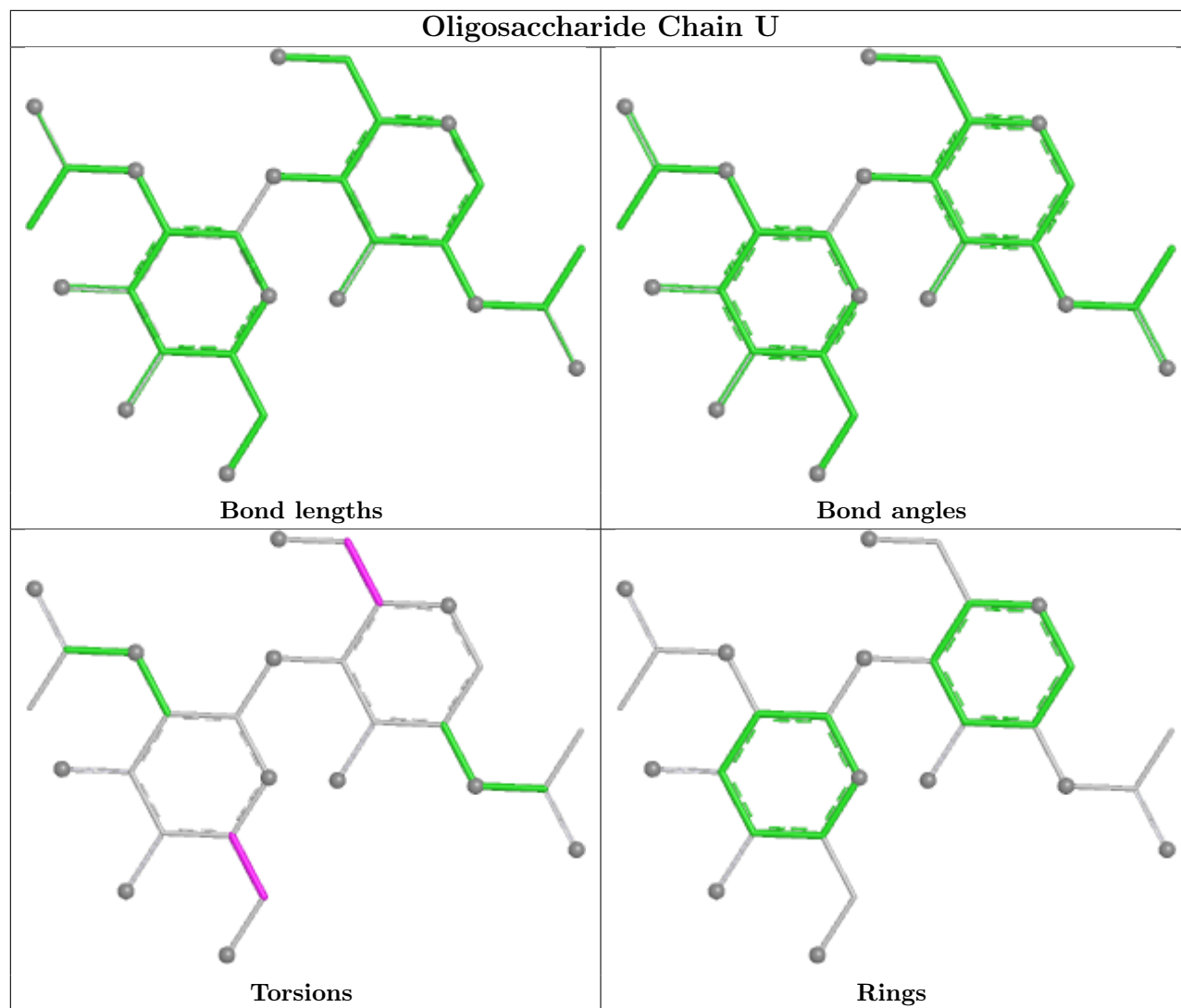

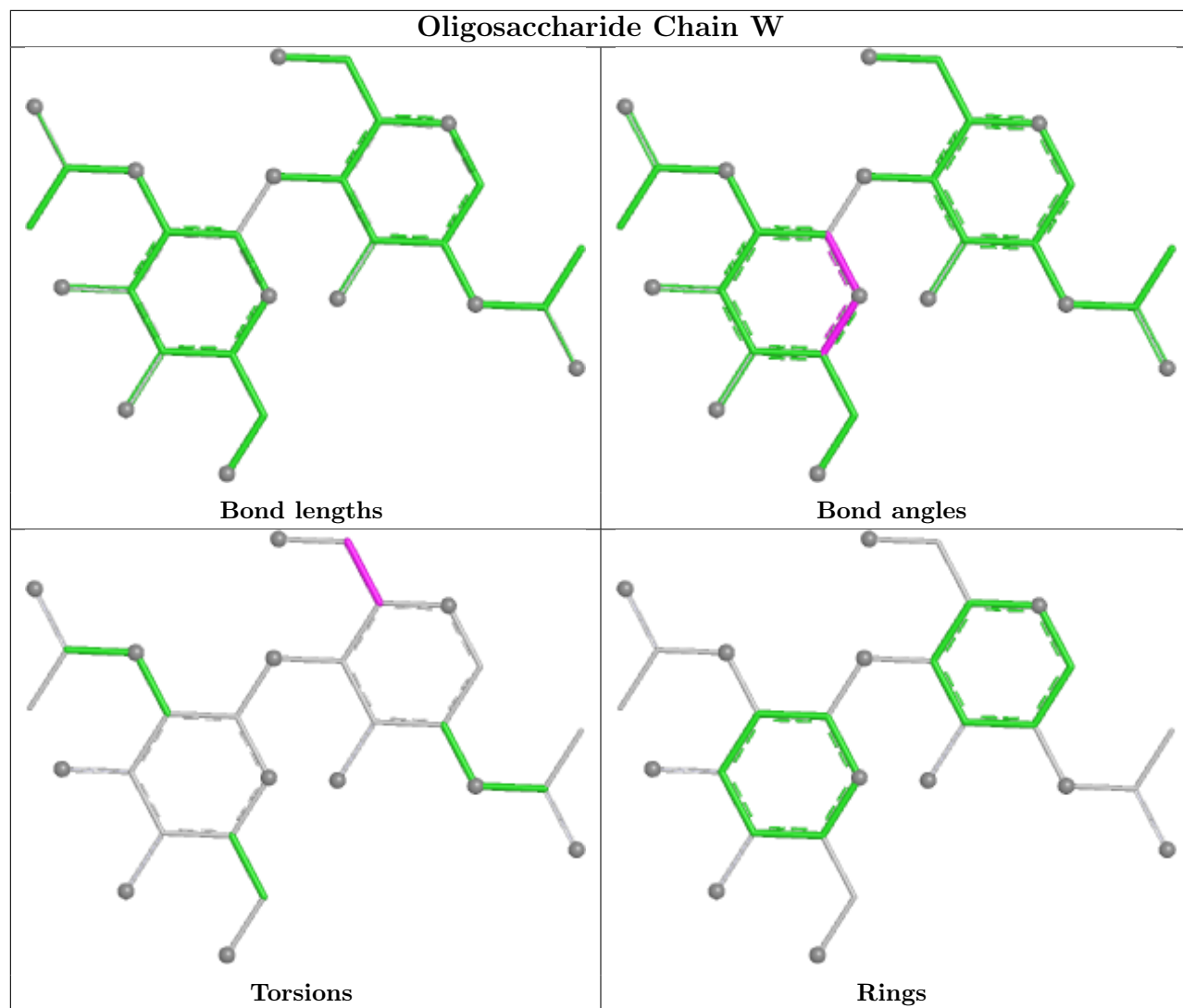

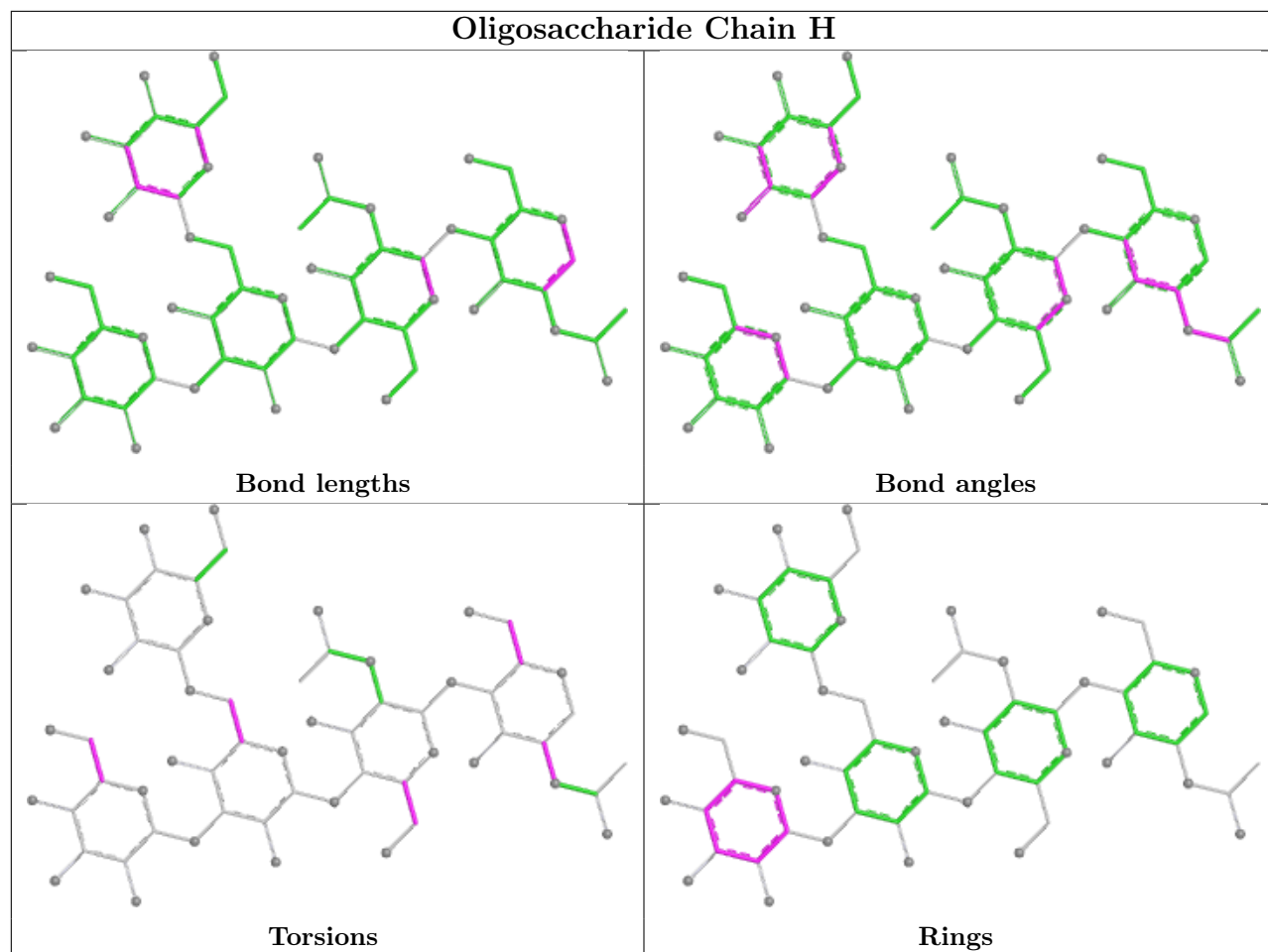

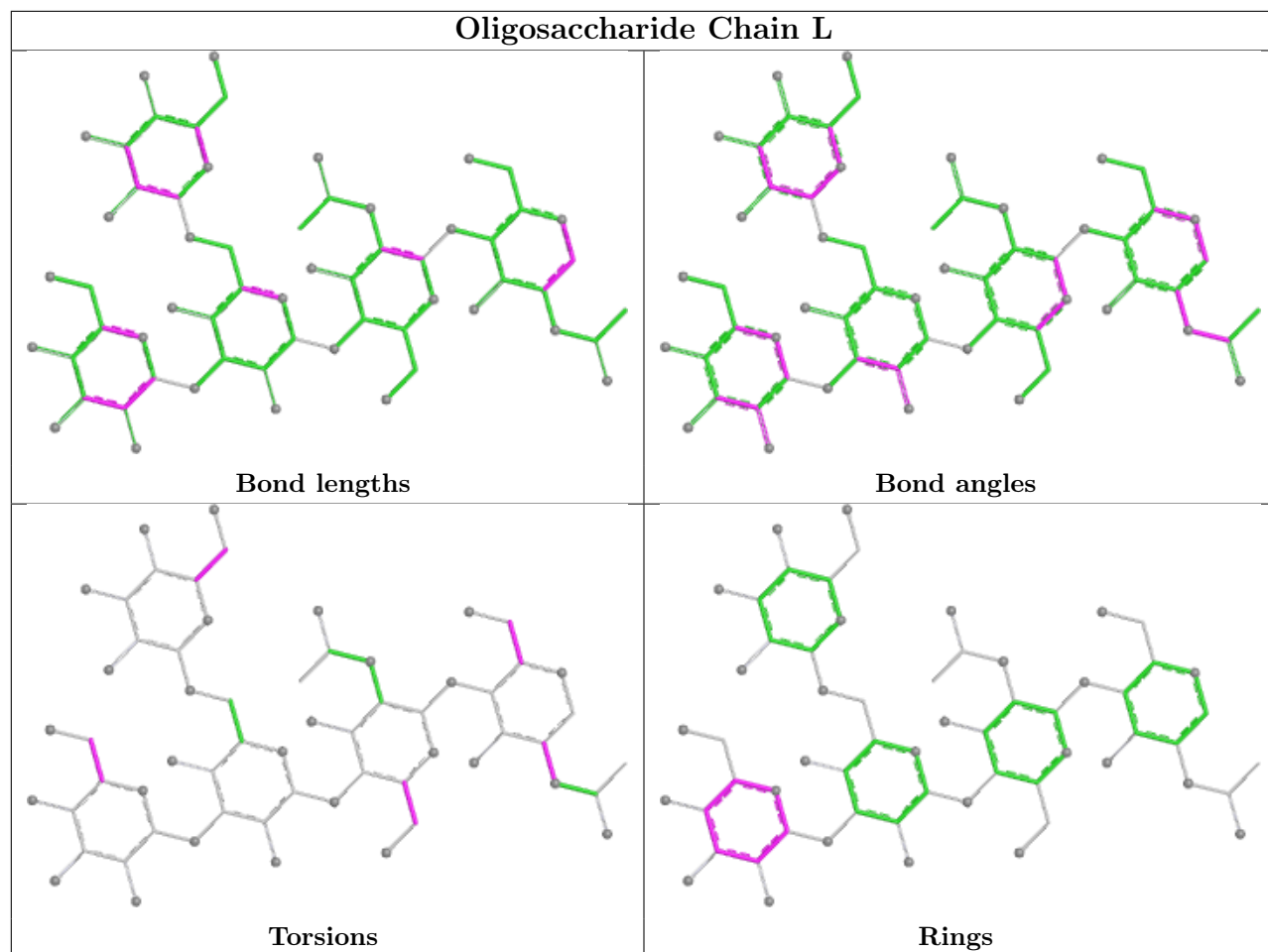

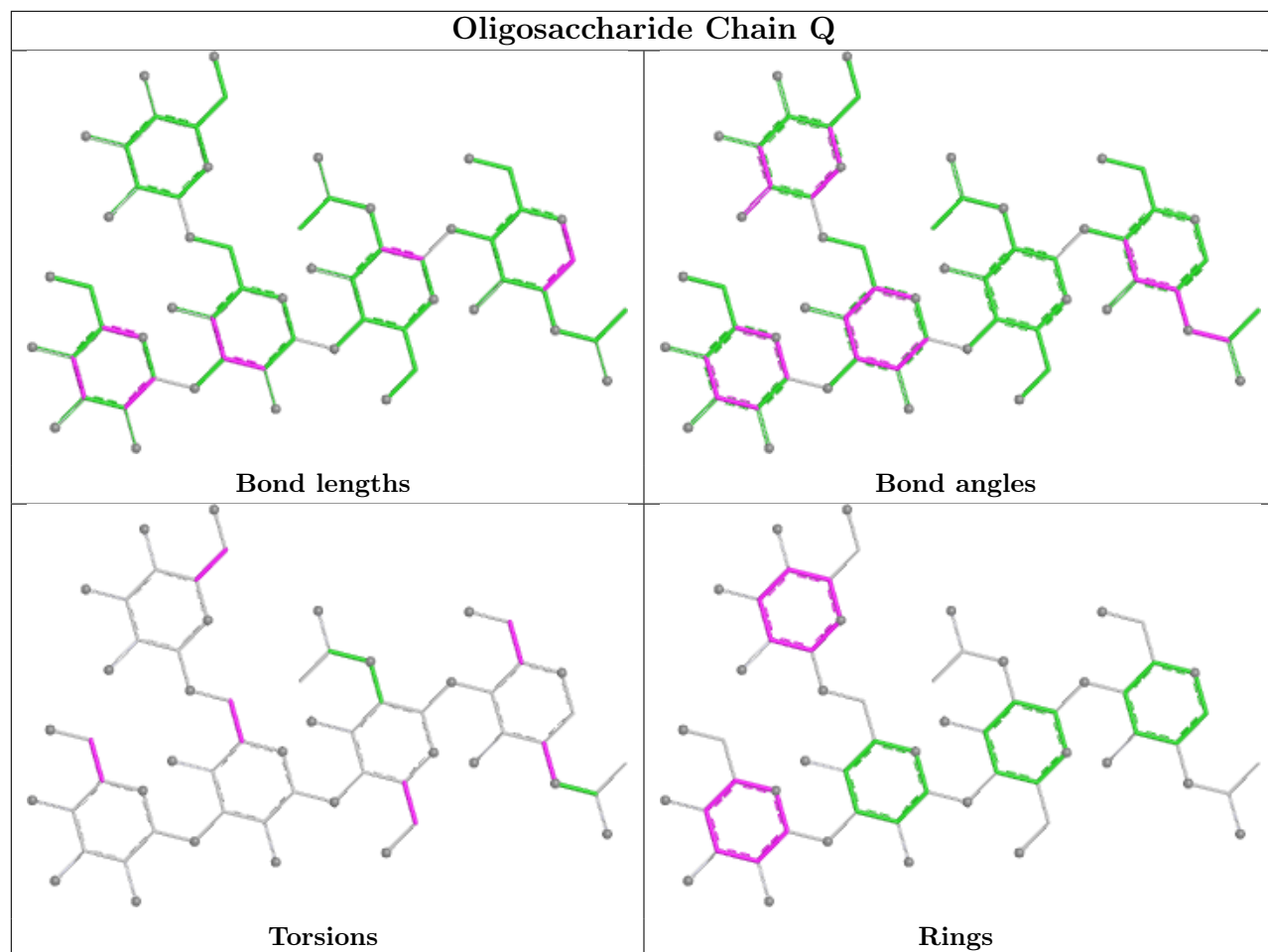

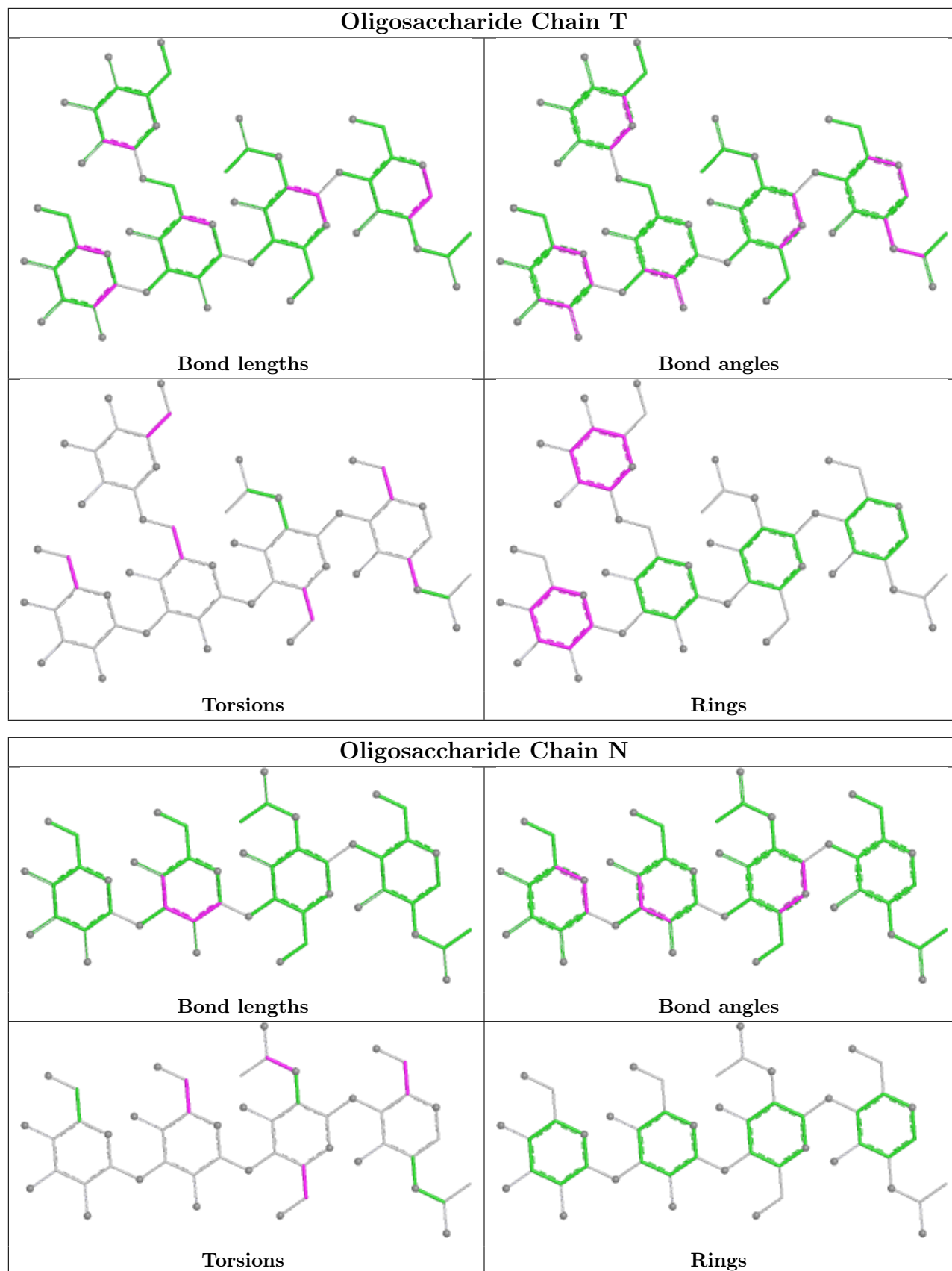

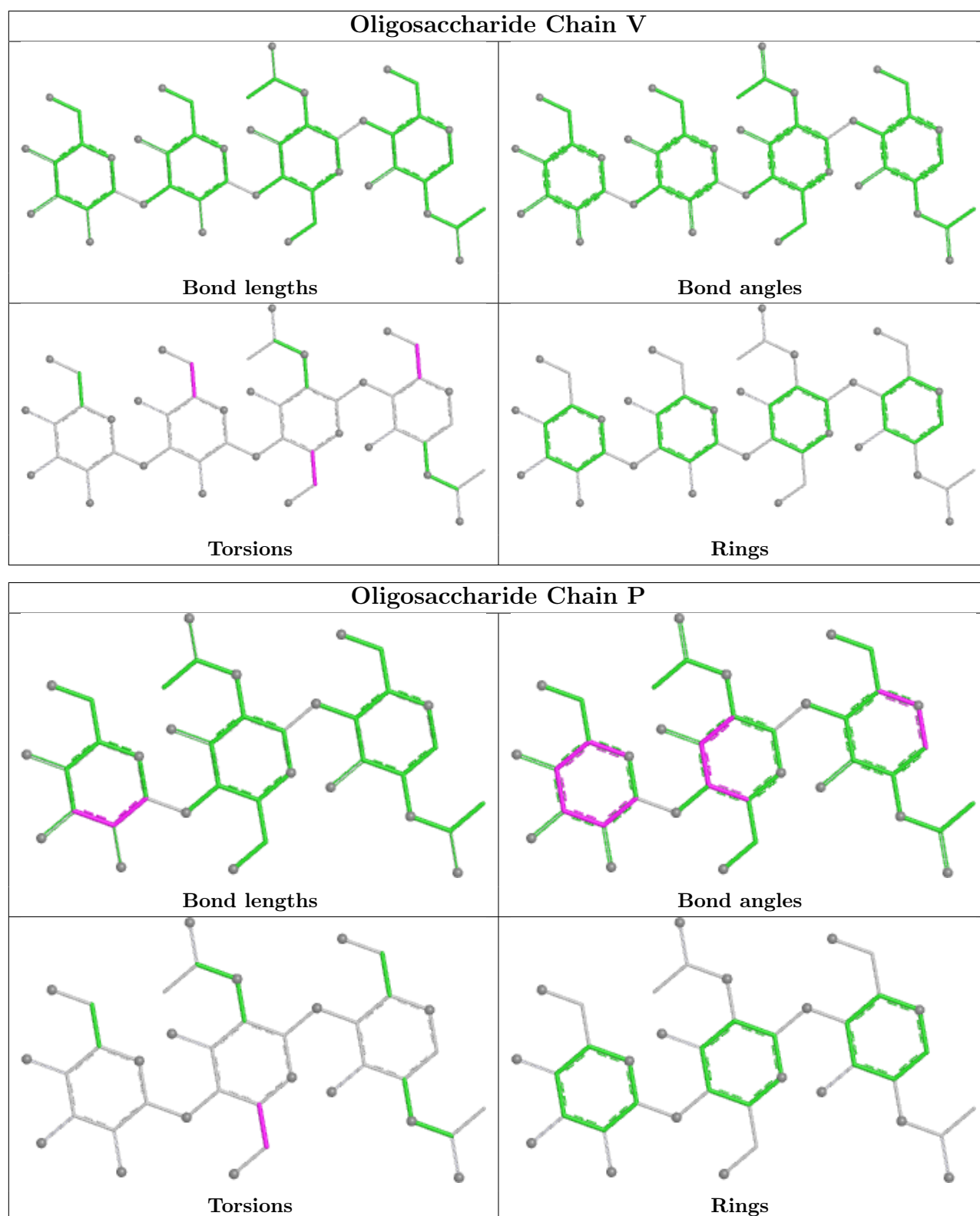

5.6 Ligand geometry [i](#)

30 ligands are modelled in this entry.

In the following table, the Counts columns list the number of bonds (or angles) for which Mogul statistics could be retrieved, the number of bonds (or angles) that are observed in the model and the number of bonds (or angles) that are defined in the Chemical Component Dictionary. The Link column lists molecule types, if any, to which the group is linked. The Z score for a bond length (or angle) is the number of standard deviations the observed value is removed from the expected value. A bond length (or angle) with $|Z| > 2$ is considered an outlier worth inspection. RMSZ is the root-mean-square of all Z scores of the bond lengths (or angles).

Mol	Type	Chain	Res	Link	Bond lengths			Bond angles		
					Counts	RMSZ	# $ Z > 2$	Counts	RMSZ	# $ Z > 2$
7	POV	D	1004	-	51,51,51	1.08	3 (5%)	57,59,59	0.90	3 (5%)
8	NAG	A	1008	1	14,14,15	1.20	1 (7%)	17,19,21	1.54	1 (5%)
8	NAG	C	1006	1	14,14,15	0.53	0	17,19,21	1.00	1 (5%)
8	NAG	C	1004	1	14,14,15	0.30	0	17,19,21	0.46	0
8	NAG	D	1006	1	14,14,15	1.48	2 (14%)	17,19,21	2.74	4 (23%)
7	POV	D	1001	-	51,51,51	1.10	3 (5%)	57,59,59	0.90	3 (5%)
7	POV	F	601	-	51,51,51	1.09	3 (5%)	57,59,59	0.93	3 (5%)
7	POV	A	1009	-	51,51,51	1.09	3 (5%)	57,59,59	0.90	3 (5%)
7	POV	C	1008	-	51,51,51	1.10	2 (3%)	57,59,59	0.99	3 (5%)
7	POV	A	1001	-	51,51,51	1.08	3 (5%)	57,59,59	1.01	3 (5%)
7	POV	D	1003	-	51,51,51	1.10	3 (5%)	57,59,59	0.90	3 (5%)
8	NAG	C	1005	1	14,14,15	0.28	0	17,19,21	0.54	0
8	NAG	A	1007	1	14,14,15	1.48	2 (14%)	17,19,21	1.49	2 (11%)
7	POV	C	1002	-	51,51,51	1.10	3 (5%)	57,59,59	0.95	3 (5%)
7	POV	A	1002	-	51,51,51	1.10	3 (5%)	57,59,59	0.94	3 (5%)
8	NAG	B	1003	1	14,14,15	0.44	0	17,19,21	0.60	0
8	NAG	A	1005	1	14,14,15	0.69	0	17,19,21	1.25	1 (5%)
7	POV	A	1003	-	51,51,51	1.09	3 (5%)	57,59,59	0.92	3 (5%)
7	POV	B	1001	-	51,51,51	1.08	3 (5%)	57,59,59	0.96	3 (5%)
8	NAG	A	1004	1	14,14,15	0.42	0	17,19,21	0.44	0
8	NAG	D	1005	1	14,14,15	0.40	0	17,19,21	0.59	1 (5%)
7	POV	D	1002	-	51,51,51	1.08	3 (5%)	57,59,59	0.96	3 (5%)
7	POV	B	1002	-	51,51,51	1.09	3 (5%)	57,59,59	0.89	3 (5%)
8	NAG	A	1006	1	14,14,15	1.31	2 (14%)	17,19,21	1.35	1 (5%)
8	NAG	B	1004	1	14,14,15	0.45	0	17,19,21	0.42	0
8	NAG	F	602	2	14,14,15	0.97	1 (7%)	17,19,21	1.09	2 (11%)
8	NAG	E	601	2	14,14,15	0.78	1 (7%)	17,19,21	1.04	1 (5%)
7	POV	C	1001	-	51,51,51	1.08	3 (5%)	57,59,59	0.96	3 (5%)
8	NAG	C	1007	1	14,14,15	1.11	2 (14%)	17,19,21	1.34	1 (5%)
7	POV	C	1003	-	51,51,51	1.09	2 (3%)	57,59,59	0.98	3 (5%)

In the following table, the Chirals column lists the number of chiral outliers, the number of chiral centers analysed, the number of these observed in the model and the number defined in the Chemical Component Dictionary. Similar counts are reported in the Torsion and Rings columns. '-' means no outliers of that kind were identified.

Mol	Type	Chain	Res	Link	Chirals	Torsions	Rings
7	POV	D	1004	-	-	29/55/55/55	-
8	NAG	A	1008	1	-	2/6/23/26	0/1/1/1
8	NAG	C	1006	1	-	2/6/23/26	0/1/1/1
8	NAG	C	1004	1	-	3/6/23/26	0/1/1/1
8	NAG	D	1006	1	-	5/6/23/26	0/1/1/1
7	POV	D	1001	-	-	26/55/55/55	-
7	POV	F	601	-	-	27/55/55/55	-
7	POV	A	1009	-	-	24/55/55/55	-
7	POV	C	1008	-	-	32/55/55/55	-
7	POV	A	1001	-	-	29/55/55/55	-
7	POV	D	1003	-	-	25/55/55/55	-
8	NAG	C	1005	1	-	3/6/23/26	0/1/1/1
8	NAG	A	1007	1	-	0/6/23/26	0/1/1/1
7	POV	C	1002	-	-	26/55/55/55	-
7	POV	A	1002	-	-	29/55/55/55	-
8	NAG	B	1003	1	-	4/6/23/26	0/1/1/1
8	NAG	A	1005	1	-	4/6/23/26	0/1/1/1
7	POV	A	1003	-	-	29/55/55/55	-
7	POV	B	1001	-	-	22/55/55/55	-
8	NAG	A	1004	1	-	0/6/23/26	0/1/1/1
8	NAG	D	1005	1	-	2/6/23/26	0/1/1/1
7	POV	D	1002	-	-	29/55/55/55	-
7	POV	B	1002	-	-	26/55/55/55	-
8	NAG	A	1006	1	-	3/6/23/26	0/1/1/1
8	NAG	B	1004	1	-	2/6/23/26	0/1/1/1
8	NAG	F	602	2	-	2/6/23/26	0/1/1/1
8	NAG	E	601	2	-	3/6/23/26	0/1/1/1
7	POV	C	1001	-	-	33/55/55/55	-
8	NAG	C	1007	1	-	3/6/23/26	0/1/1/1
7	POV	C	1003	-	-	27/55/55/55	-

The worst 5 of 54 bond length outliers are listed below:

Mol	Chain	Res	Type	Atoms	Z	Observed(Å)	Ideal(Å)
8	A	1007	NAG	O5-C1	4.63	1.51	1.43
8	D	1006	NAG	O5-C1	4.12	1.50	1.43
8	A	1008	NAG	O5-C1	4.09	1.50	1.43
8	A	1006	NAG	O5-C1	3.93	1.50	1.43
8	C	1007	NAG	O5-C1	3.48	1.49	1.43

The worst 5 of 60 bond angle outliers are listed below:

Mol	Chain	Res	Type	Atoms	Z	Observed(°)	Ideal(°)
8	D	1006	NAG	C2-N2-C7	8.26	133.97	122.90
8	A	1008	NAG	C1-O5-C5	6.08	120.33	112.19
8	D	1006	NAG	C1-O5-C5	5.91	120.10	112.19
8	A	1007	NAG	C1-O5-C5	5.56	119.64	112.19
8	A	1006	NAG	C1-O5-C5	5.18	119.13	112.19

There are no chirality outliers.

5 of 451 torsion outliers are listed below:

Mol	Chain	Res	Type	Atoms
7	A	1001	POV	C1-O11-P-O12
7	A	1001	POV	C1-O11-P-O14
7	A	1001	POV	C22-C21-O21-C2
7	A	1002	POV	C1-O11-P-O12
7	A	1002	POV	C1-O11-P-O14

There are no ring outliers.

15 monomers are involved in 33 short contacts:

Mol	Chain	Res	Type	Clashes	Symm-Clashes
7	D	1004	POV	2	0
7	D	1001	POV	4	0
7	F	601	POV	1	0
7	A	1009	POV	2	0
7	C	1008	POV	4	0
7	A	1001	POV	2	0
7	D	1003	POV	3	0
7	C	1002	POV	4	0
7	A	1002	POV	1	0
7	B	1001	POV	2	0
7	D	1002	POV	4	0
7	B	1002	POV	2	0
8	A	1006	NAG	1	0

Continued on next page...

Continued from previous page...

Mol	Chain	Res	Type	Clashes	Symm-Clashes
7	C	1001	POV	2	0
7	C	1003	POV	3	0

The following is a two-dimensional graphical depiction of Mogul quality analysis of bond lengths, bond angles, torsion angles, and ring geometry for all instances of the Ligand of Interest. In addition, ligands with molecular weight > 250 and outliers as shown on the validation Tables will also be included. For torsion angles, if less than 5% of the Mogul distribution of torsion angles is within 10 degrees of the torsion angle in question, then that torsion angle is considered an outlier. Any bond that is central to one or more torsion angles identified as an outlier by Mogul will be highlighted in the graph. For rings, the root-mean-square deviation (RMSD) between the ring in question and similar rings identified by Mogul is calculated over all ring torsion angles. If the average RMSD is greater than 60 degrees and the minimal RMSD between the ring in question and any Mogul-identified rings is also greater than 60 degrees, then that ring is considered an outlier. The outliers are highlighted in purple. The color gray indicates Mogul did not find sufficient equivalents in the CSD to analyse the geometry.

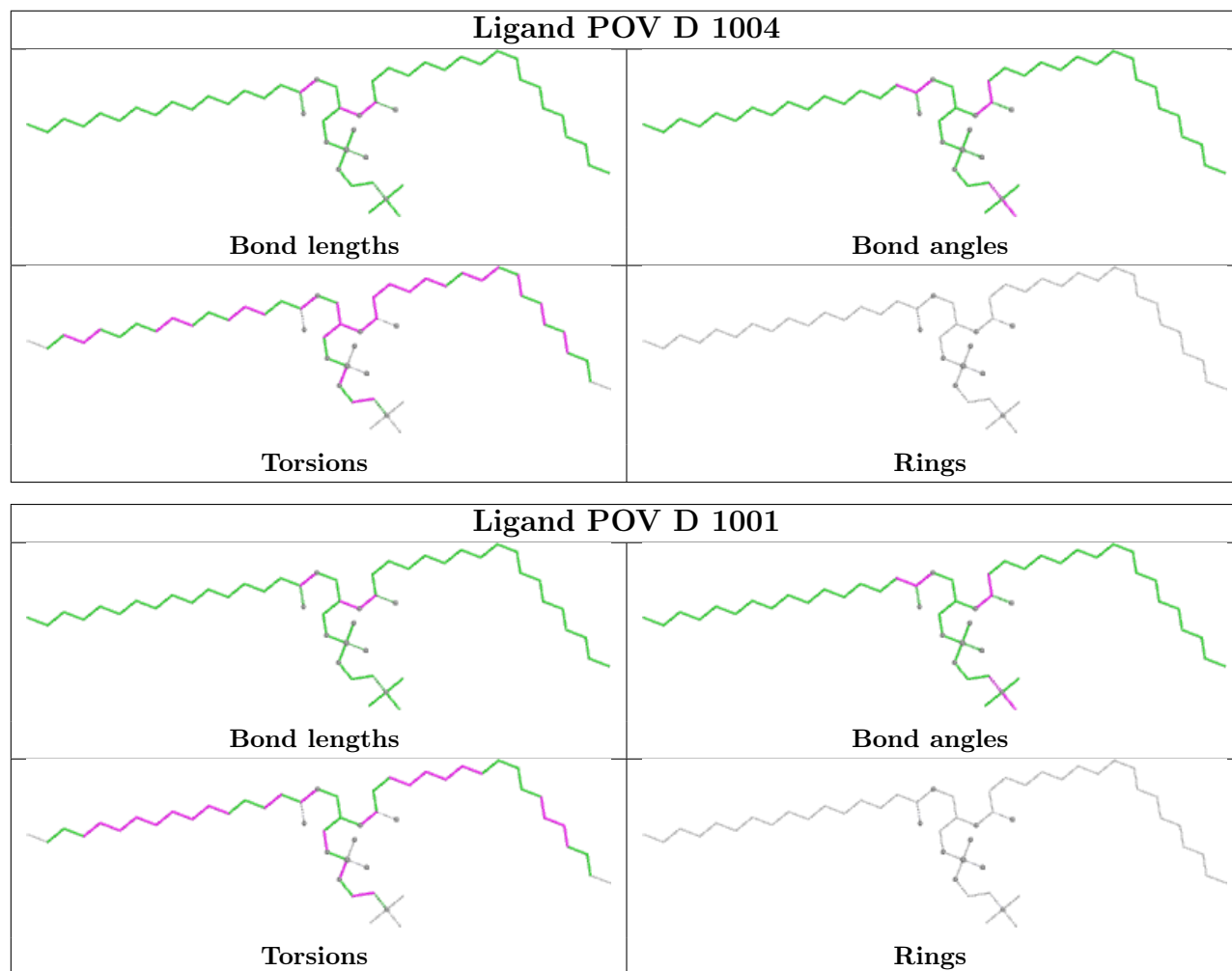

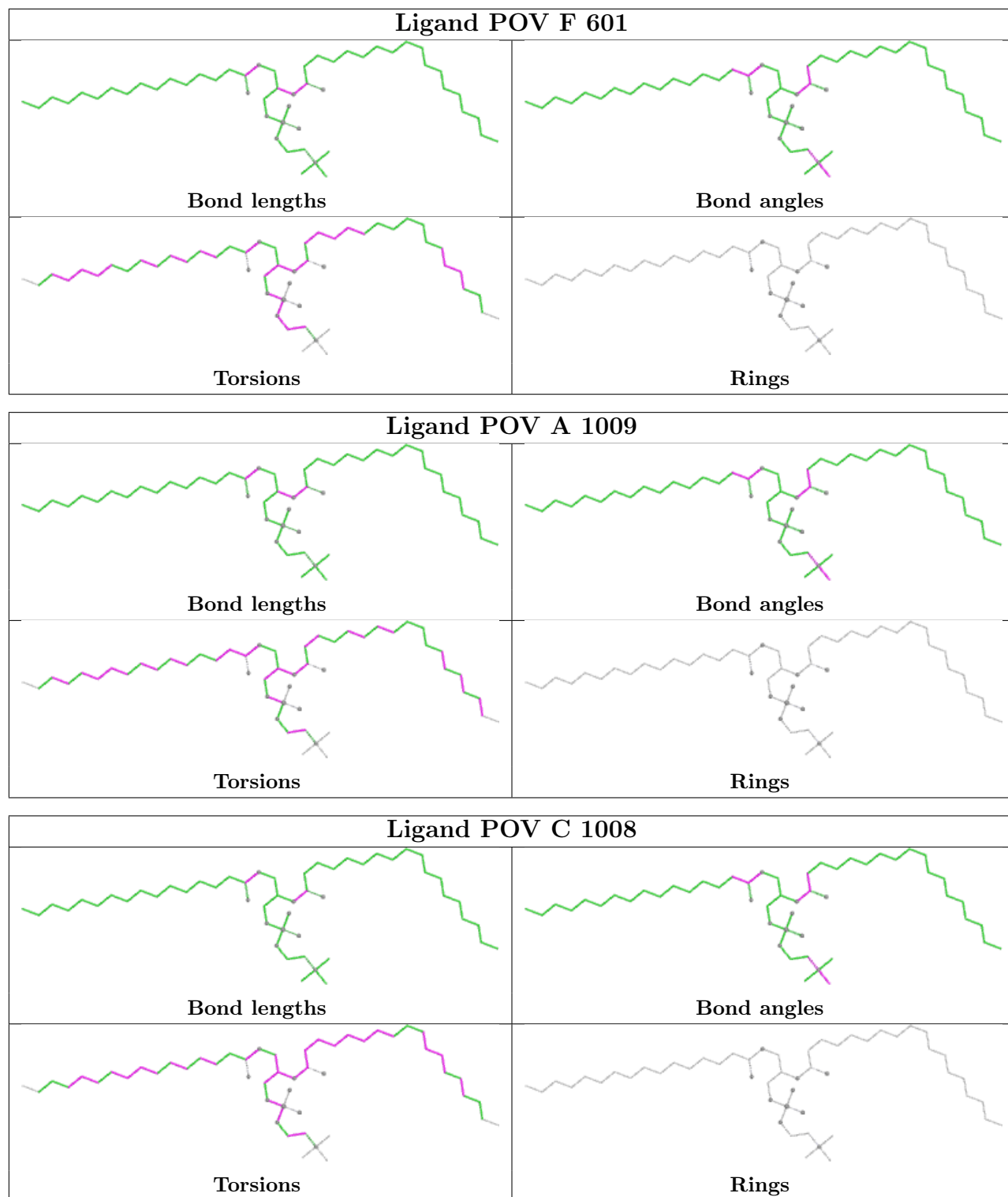

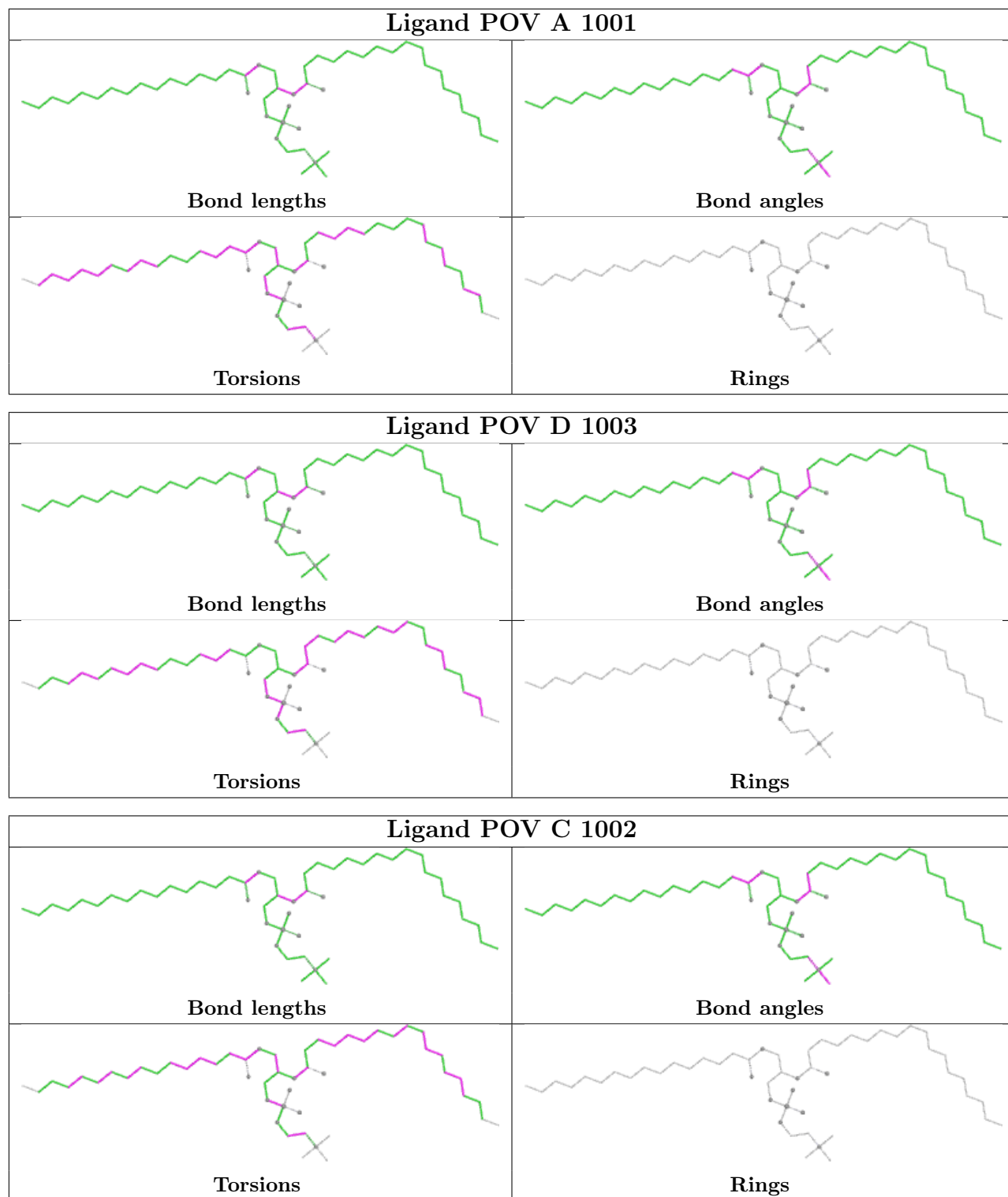

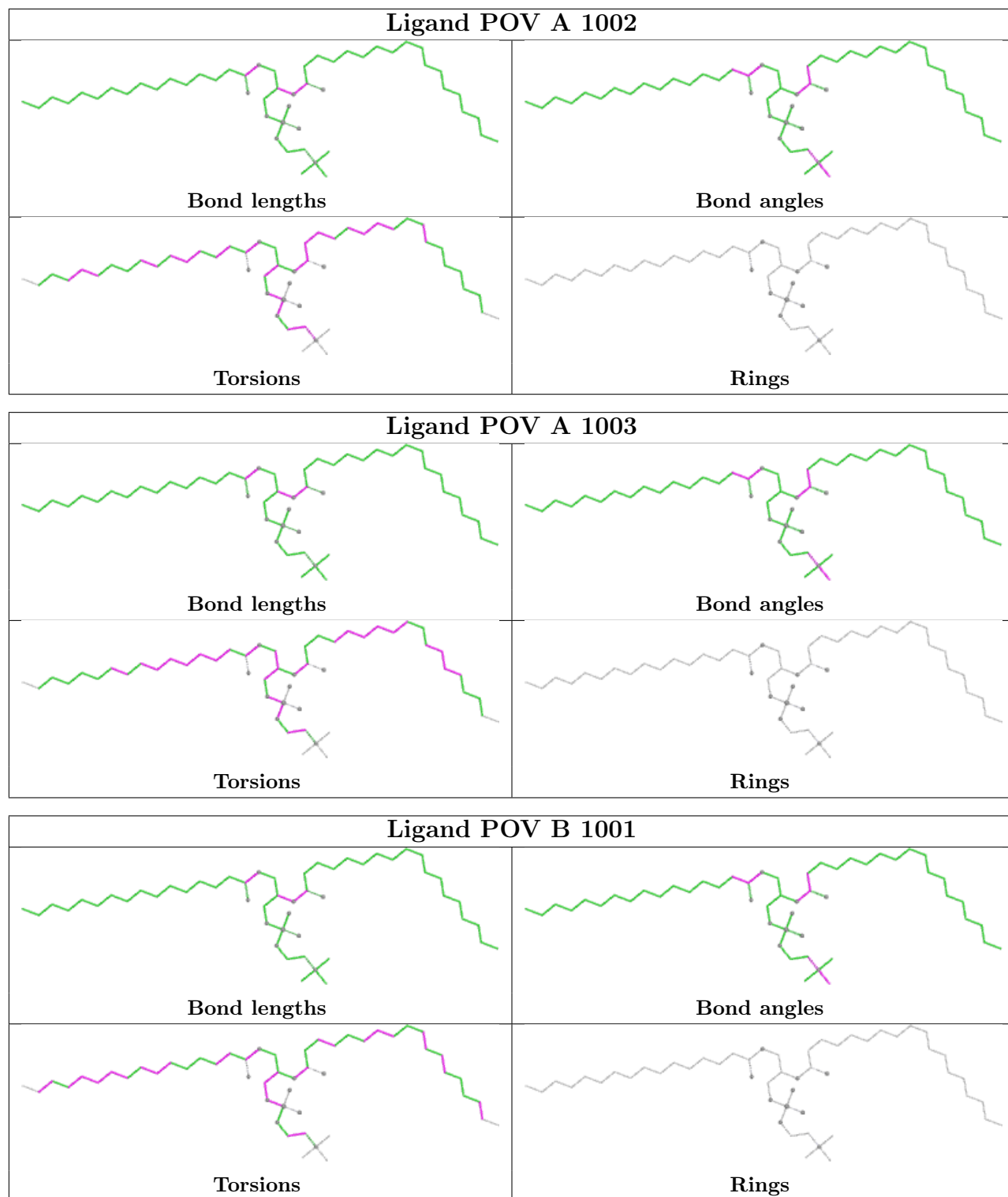

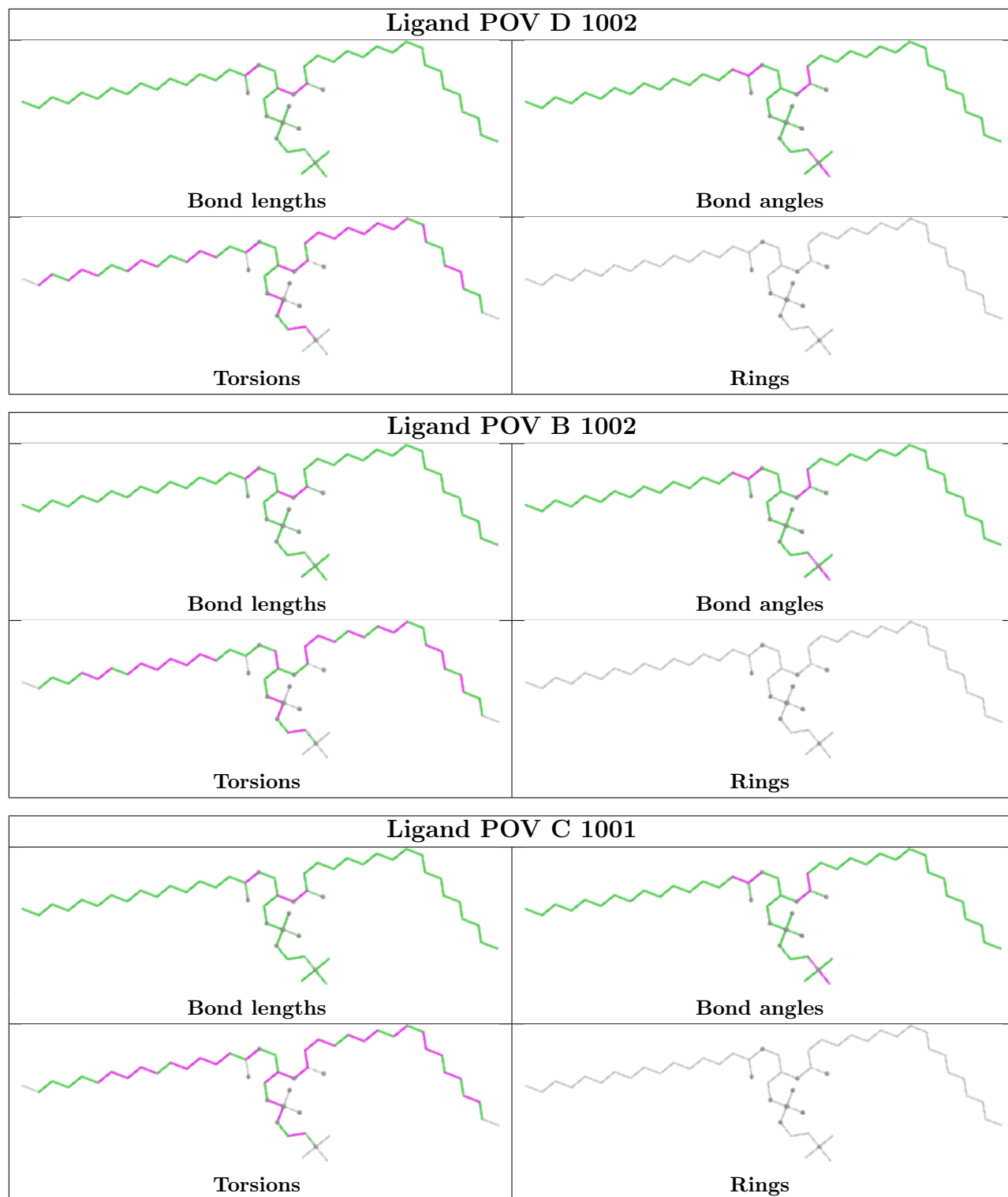

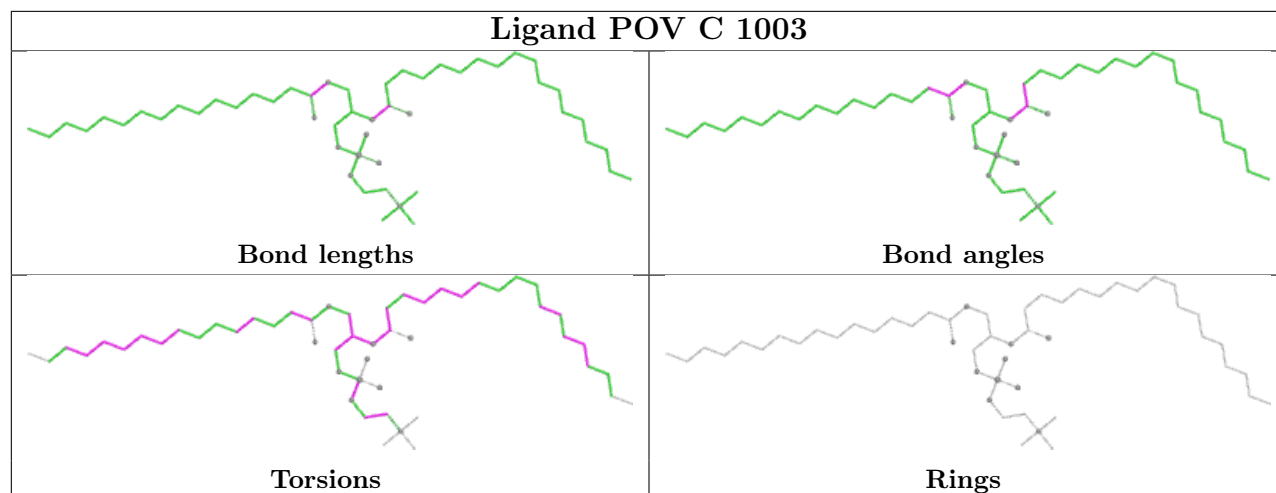

5.7 Other polymers [i](#)

There are no such residues in this entry.

5.8 Polymer linkage issues [i](#)

There are no chain breaks in this entry.

6 Map visualisation [i](#)

This section contains visualisations of the EMDB entry EMD-48902. These allow visual inspection of the internal detail of the map and identification of artifacts.

No raw map or half-maps were deposited for this entry and therefore no images, graphs, etc. pertaining to the raw map can be shown.

6.1 Orthogonal projections [i](#)

6.1.1 Primary map

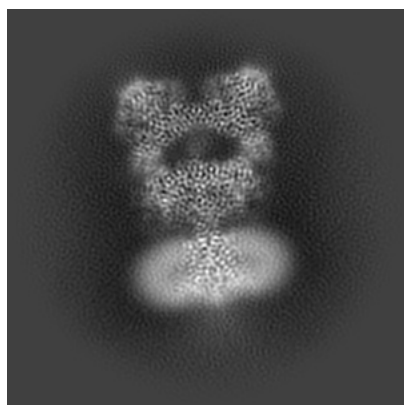

X

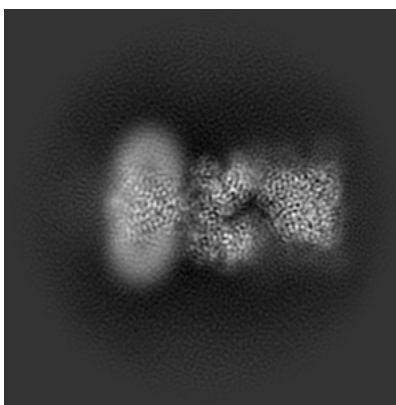

Y

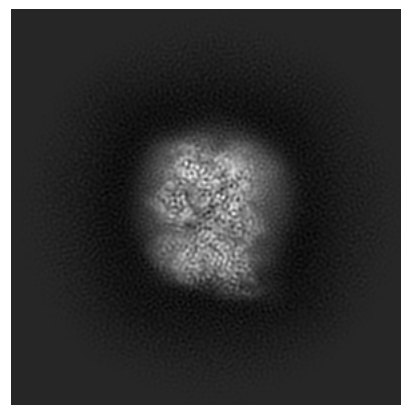

Z

The images above show the map projected in three orthogonal directions.

6.2 Central slices [i](#)

6.2.1 Primary map

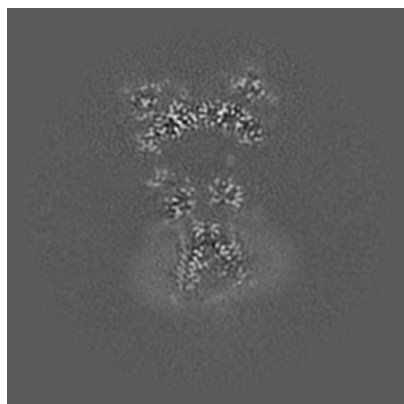

X Index: 200

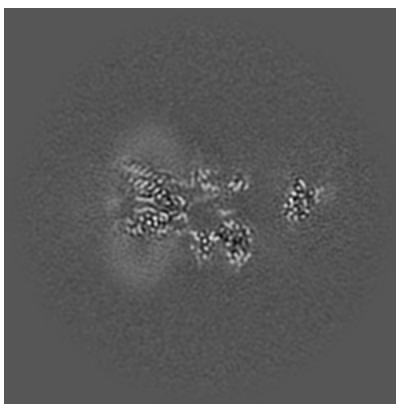

Y Index: 200

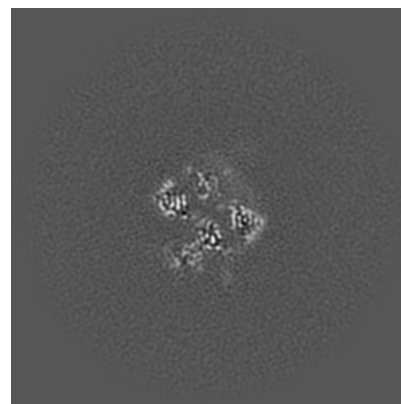

Z Index: 200

The images above show central slices of the map in three orthogonal directions.

6.3 Largest variance slices [i](#)

6.3.1 Primary map

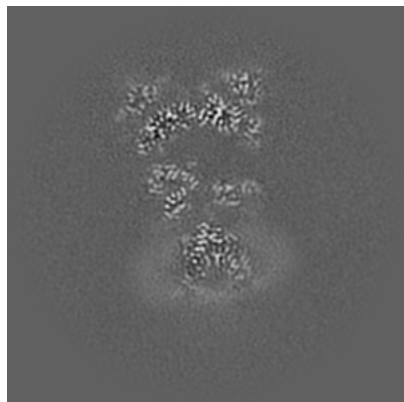

X Index: 206

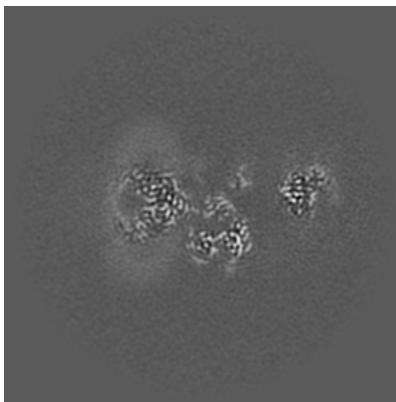

Y Index: 209

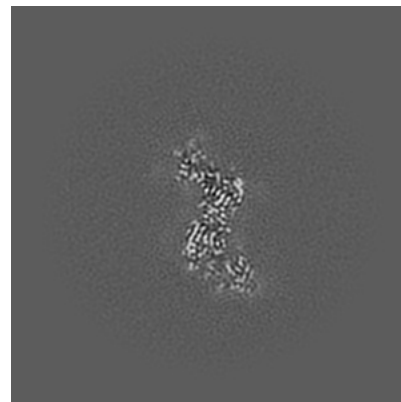

Z Index: 292

The images above show the largest variance slices of the map in three orthogonal directions.

6.4 Orthogonal standard-deviation projections (False-color) [i](#)

6.4.1 Primary map

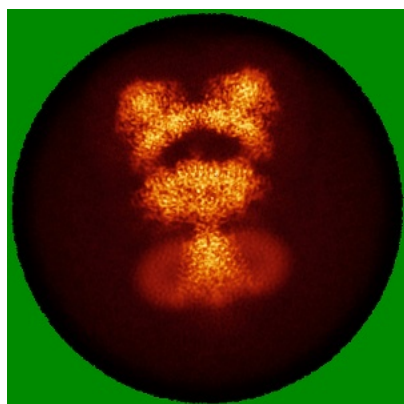

X

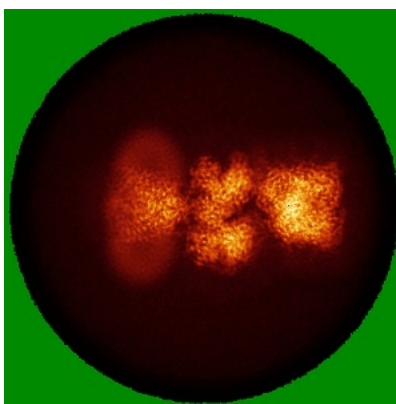

Y

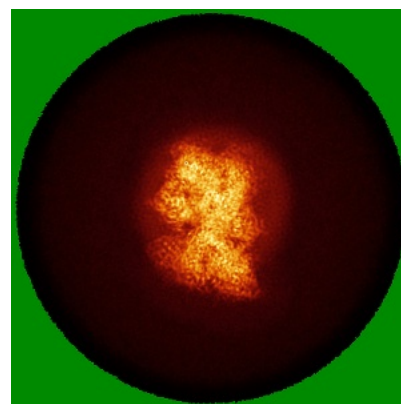

Z

The images above show the map standard deviation projections with false color in three orthogonal directions. Minimum values are shown in green, max in blue, and dark to light orange shades represent small to large values respectively.

6.5 Orthogonal surface views [i](#)

6.5.1 Primary map



X

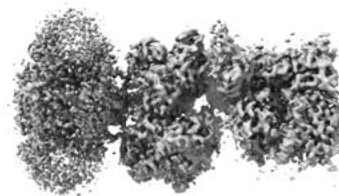

Y

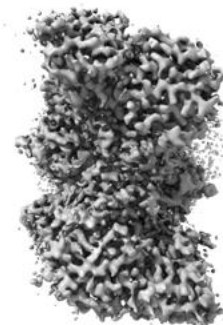

Z

The images above show the 3D surface view of the map at the recommended contour level 4.8. These images, in conjunction with the slice images, may facilitate assessment of whether an appropriate contour level has been provided.

6.6 Mask visualisation [i](#)

This section was not generated. No masks/segmentation were deposited.

7 Map analysis [i](#)

This section contains the results of statistical analysis of the map.

7.1 Map-value distribution [i](#)

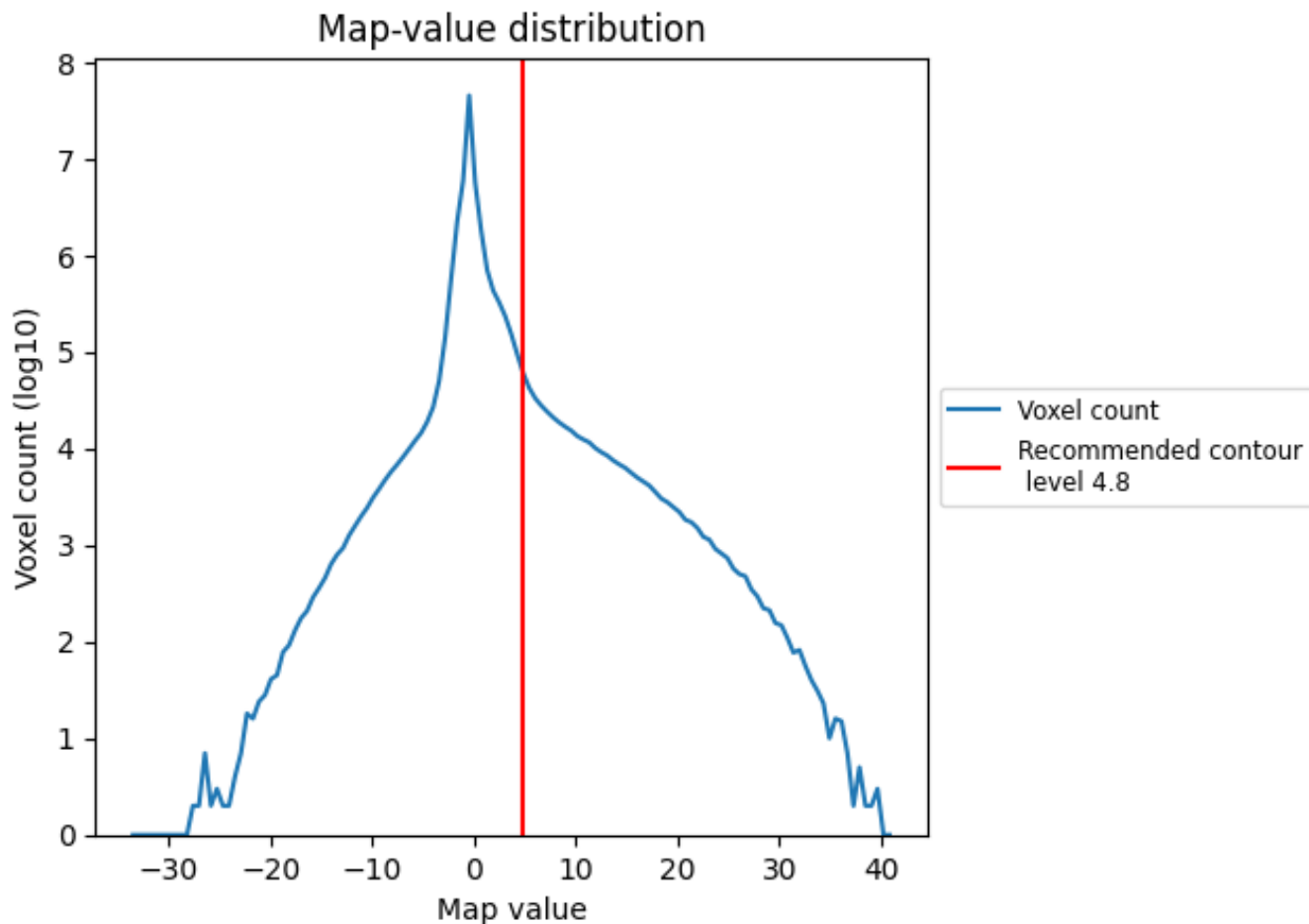

The map-value distribution is plotted in 128 intervals along the x-axis. The y-axis is logarithmic. A spike in this graph at zero usually indicates that the volume has been masked.

7.2 Volume estimate [i](#)

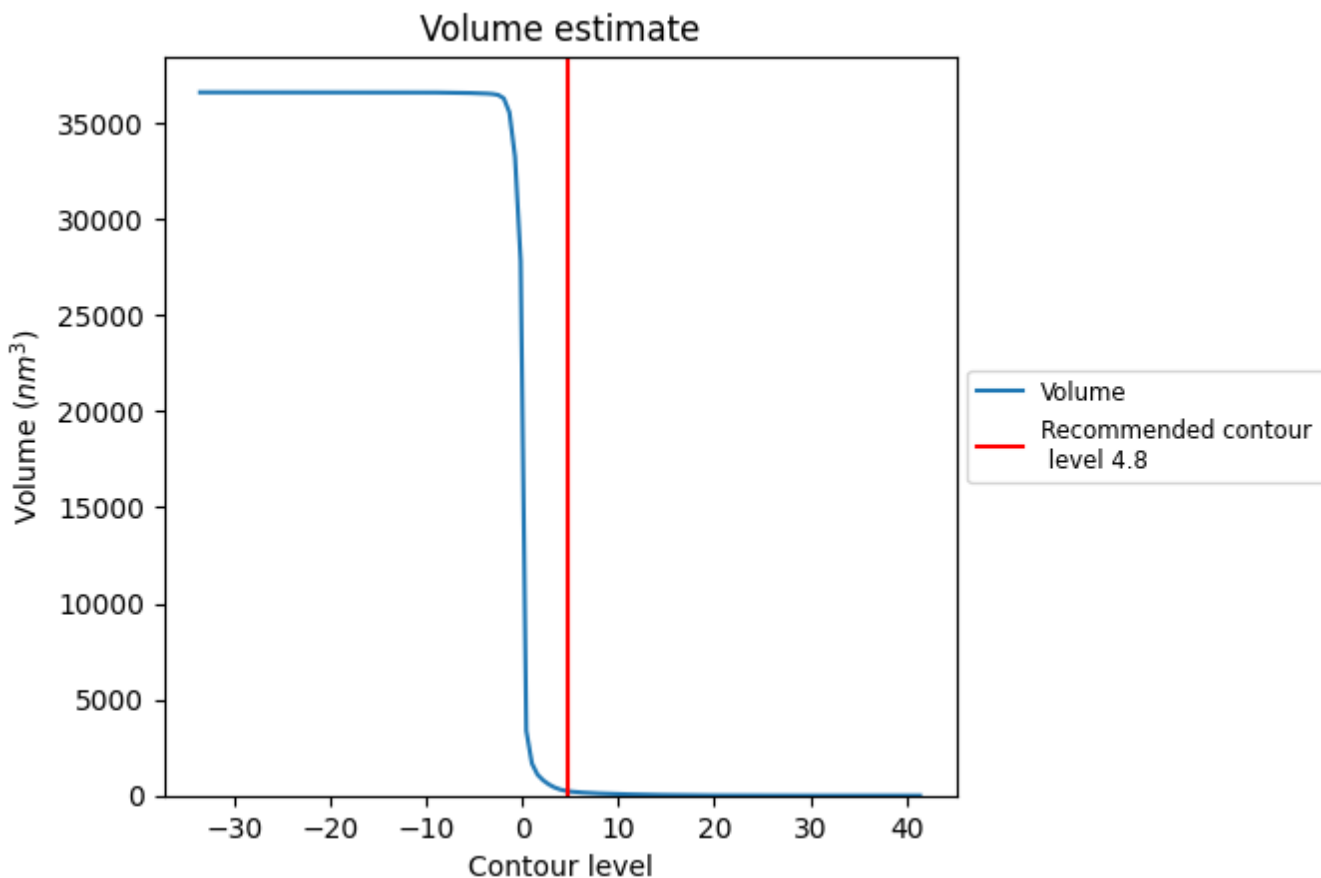

The volume at the recommended contour level is 229 nm³; this corresponds to an approximate mass of 207 kDa.

The volume estimate graph shows how the enclosed volume varies with the contour level. The recommended contour level is shown as a vertical line and the intersection between the line and the curve gives the volume of the enclosed surface at the given level.

7.3 Rotationally averaged power spectrum [\(i\)](#)

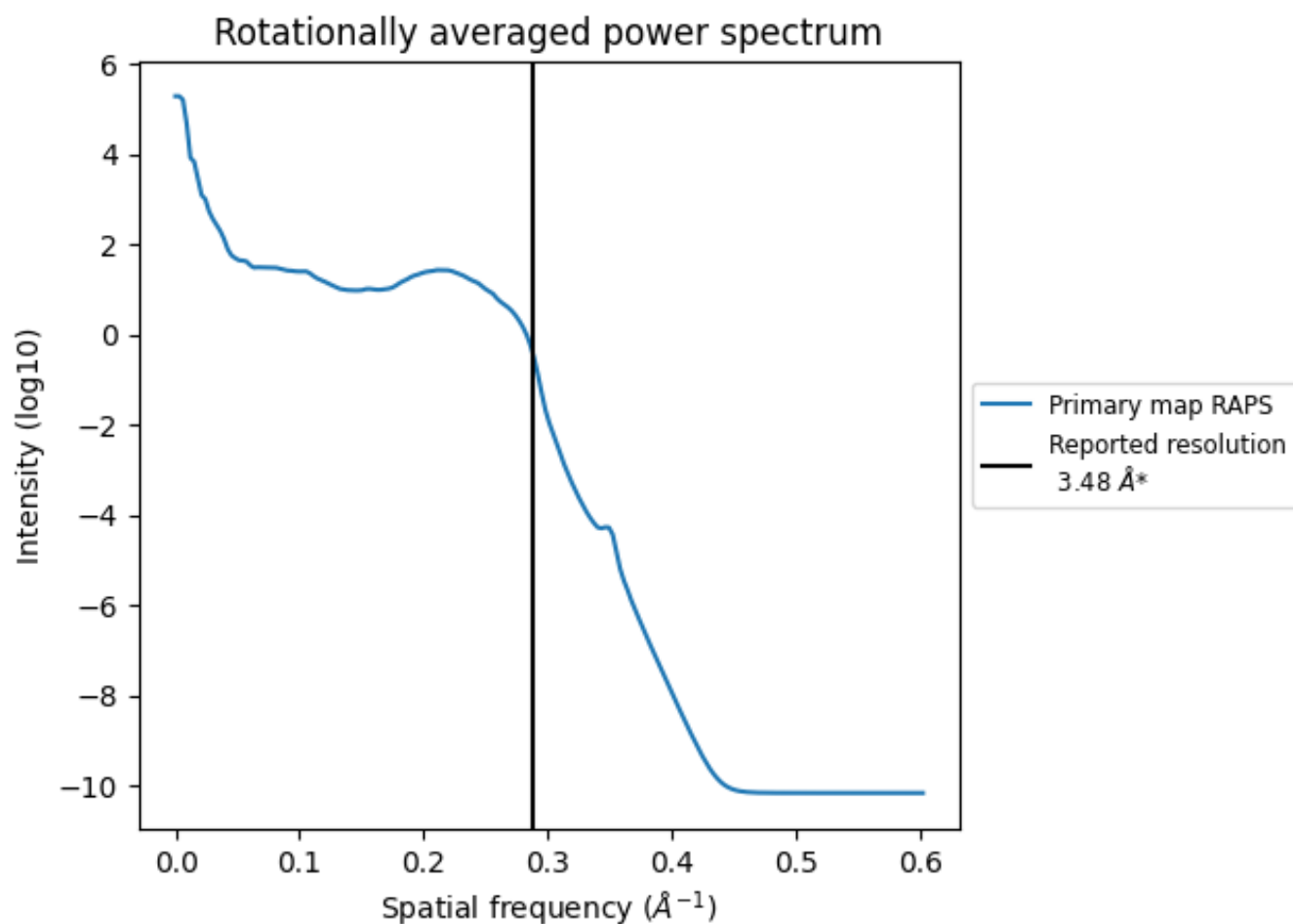

*Reported resolution corresponds to spatial frequency of 0.287 Å⁻¹

8 Fourier-Shell correlation

This section was not generated. No FSC curve or half-maps provided.

9 Map-model fit [i](#)

This section contains information regarding the fit between EMDB map EMD-48902 and PDB model 9N4Q. Per-residue inclusion information can be found in section 3 on page 10.

9.1 Map-model overlay [i](#)

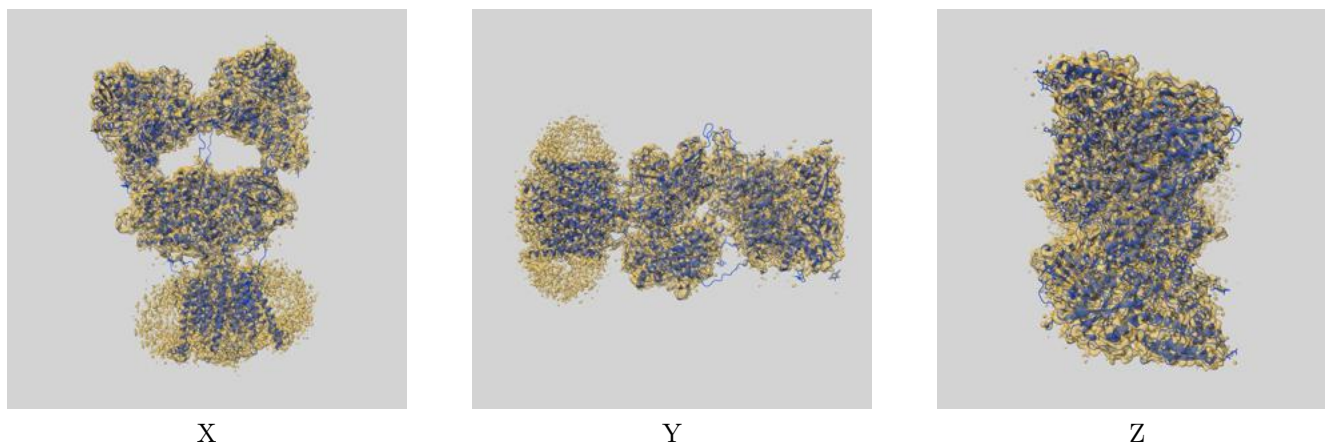

The images above show the 3D surface view of the map at the recommended contour level 4.8 at 50% transparency in yellow overlaid with a ribbon representation of the model coloured in blue. These images allow for the visual assessment of the quality of fit between the atomic model and the map.

9.2 Q-score mapped to coordinate model [i](#)

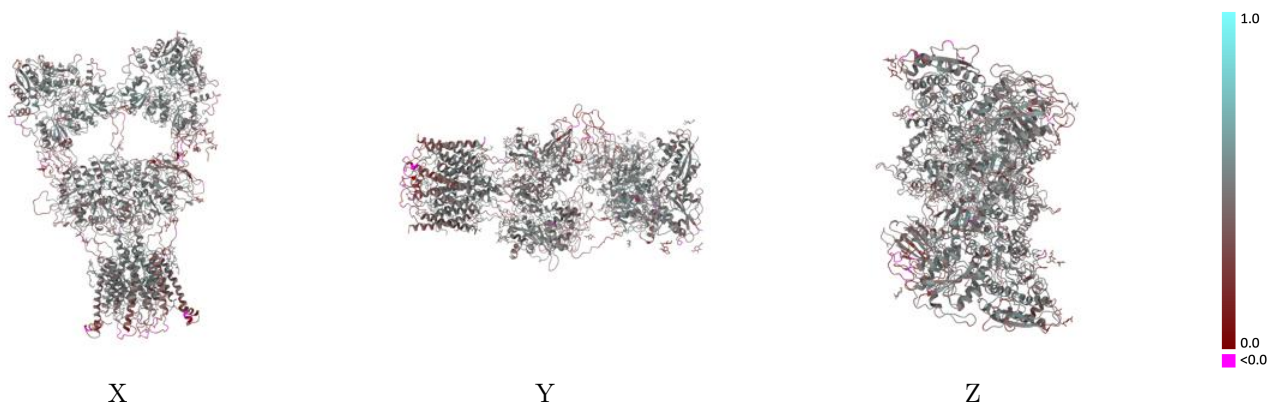

The images above show the model with each residue coloured according to its Q-score. This shows their resolvability in the map with higher Q-score values reflecting better resolvability. Please note: Q-score is calculating the resolvability of atoms, and thus high values are only expected at resolutions at which atoms can be resolved. Low Q-score values may therefore be expected for many entries.

9.3 Atom inclusion mapped to coordinate model [i](#)

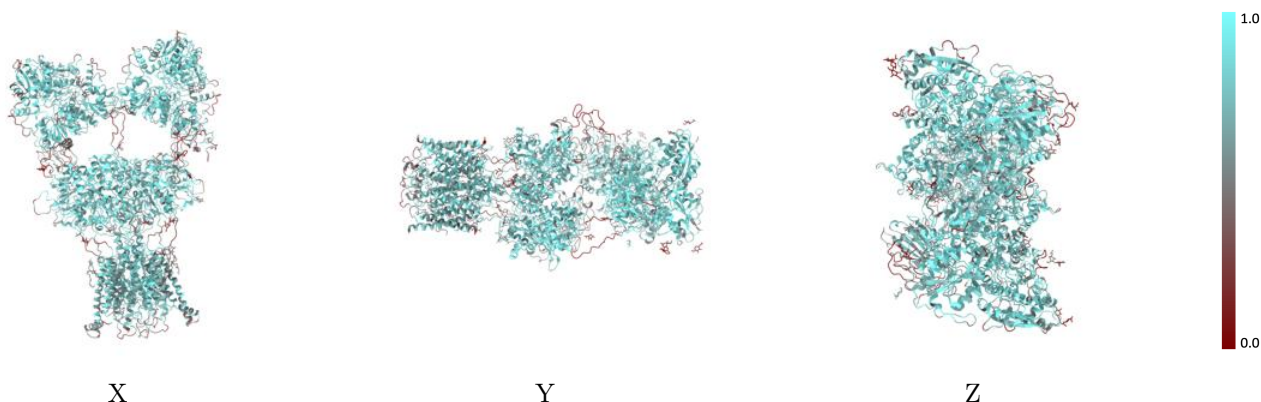

The images above show the model with each residue coloured according to its atom inclusion. This shows to what extent they are inside the map at the recommended contour level (4.8).



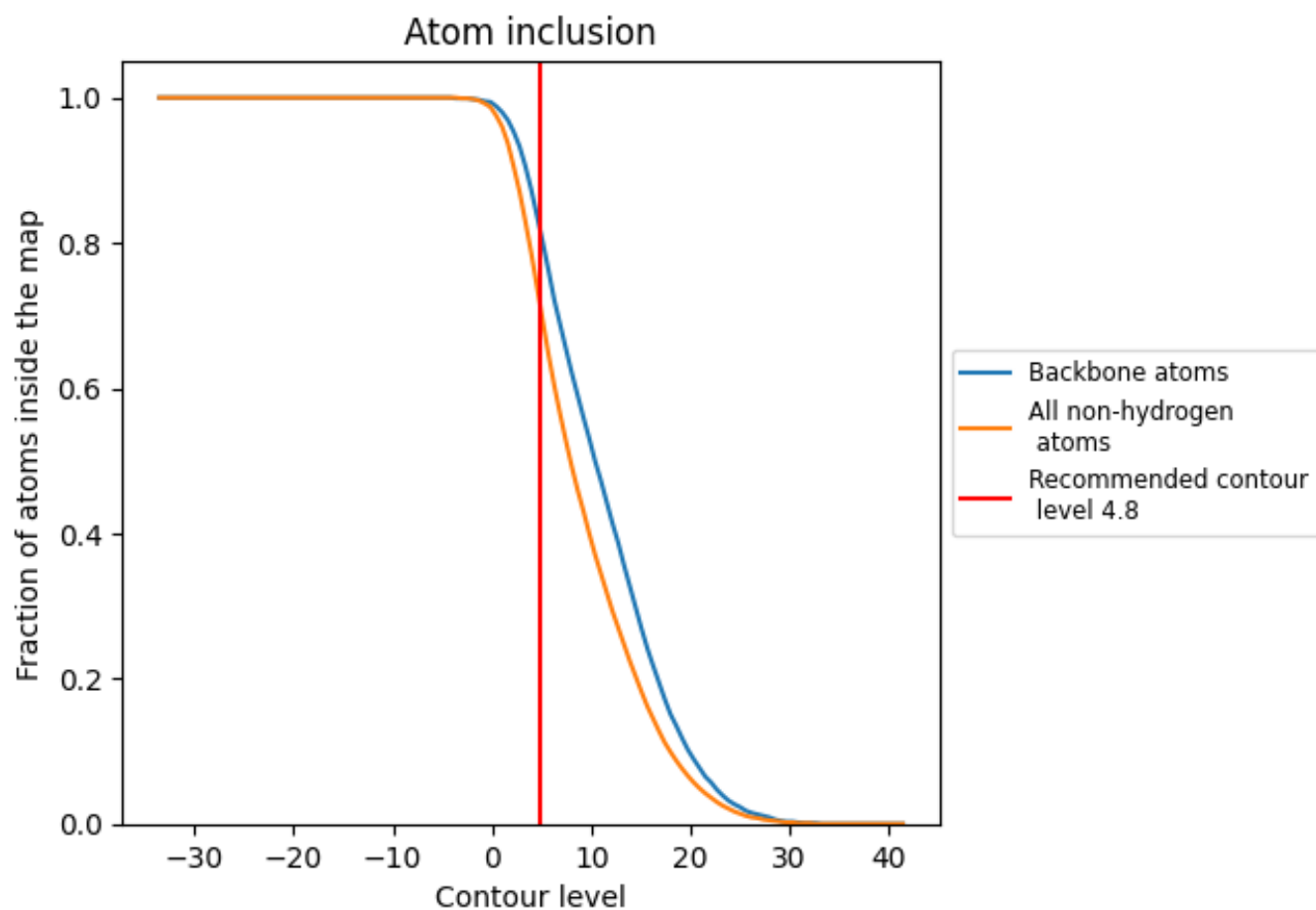













































9.4 Atom inclusion [i](#)



At the recommended contour level, 82% of all backbone atoms, 72% of all non-hydrogen atoms, are inside the map.

9.5 Map-model fit summary

The table lists the average atom inclusion at the recommended contour level (4.8) and Q-score for the entire model and for each chain.

Chain	Atom inclusion	Q-score
All	 0.7180	 0.4230
A	 0.7330	 0.4330
B	 0.7730	 0.4540
C	 0.7450	 0.4340
D	 0.7710	 0.4590
E	 0.5800	 0.3290
F	 0.5400	 0.3210
G	 0.3570	 0.3840
H	 0.4590	 0.3910
I	 0.3210	 0.3130
J	 0.1430	 0.2770
K	 0.6070	 0.4020
L	 0.6230	 0.3730
M	 0.4290	 0.3430
N	 0.6600	 0.4680
O	 0.3210	 0.2710
P	 0.1280	 0.2250
Q	 0.6720	 0.4190
R	 0.0360	 0.2540
S	 0.5710	 0.2650
T	 0.6560	 0.4300
U	 0.4640	 0.3770
V	 0.6200	 0.4350
W	 0.3210	 0.4140

